

This catalog contains part numbers for the most common replacement parts for Berko heaters shown in the Table of Contents. Additional parts for these heaters may be available - consult factory for availability. Parts for Berko heaters not listed in the Table of Contents may be available - consult factory for availability.

TABLE OF CONTENTS

BASEBOARD	UNIT HEATERS	RADIANT
(2500 Series & BKOC)..... 2	CUH900 19	VRP & VRS 38
Baseboard Accessories 4	PHFP25 21	JRK 39
HBB 5	HUH 22	RCC 40
WALL HEATERS	BDH MODEL D..... 23	PORTABLE
SSARWH 6	BSDH 24	QPH4A 29
SSHOWH 7	BPH 25	FBE 41
HT 8	HUHA AFC..... 26	LFP 41
FRC (WH-FC) 9	HUH524TA & HUH724ST 28	FHP 42
FRA (WHB3000) 10	PH5 29	INDUSTRIAL PRODUCTS
SRA (WHB1000) 11	BWD 30	DOE CEILING FANS 43
SRA ARCHITECTURAL SERIES 12	CONVECTORS	
VFK 13	UCJ 31	
GFR 14	ASL 32	
SED 15	BDBSL 33	
COS-E 16	ICST 34	
SPECIALITY HEATERS	CSL 35	
QTS 17	CPL 35	
FDI 17	ASLC 36	
WHT 17	THX 37	
CEILING HEATERS		
QCH 18		
QFF 18		
FFCH 18		

OBSOLETE PRODUCTS

SOME PARTS MAY NO LONGER BE AVAILABLE FOR OBSOLETE PRODUCTS	CEILING HEATERS	RADIANT
WALL HEATERS	SCH 50	FFR 64
MCSSAR 44	UNIT HEATERS	PMRR 64
QFG 45	TBX 57	RH 65
MFQ 46	CUH 58	INDUSTRIAL PRODUCTS
ECP 47	VUH 58	COMMERCIAL CEILING FANS 66
MFA 48	VUH-A 58	
CRA 49	HUHAA 59	
BVP 50	BDH 61	
A2500 50	CONVECTORS	
1235 & 2435 51	CC & DCC 62	
B2400 51	DB 62	
SR 52	SPECIALITY HEATERS	
SRA 53	CFWF 17	
FR 54	BASEBOARD	
FRA 55	OBD 5	
FRC 56	PORTABLE	
	WPC 63	

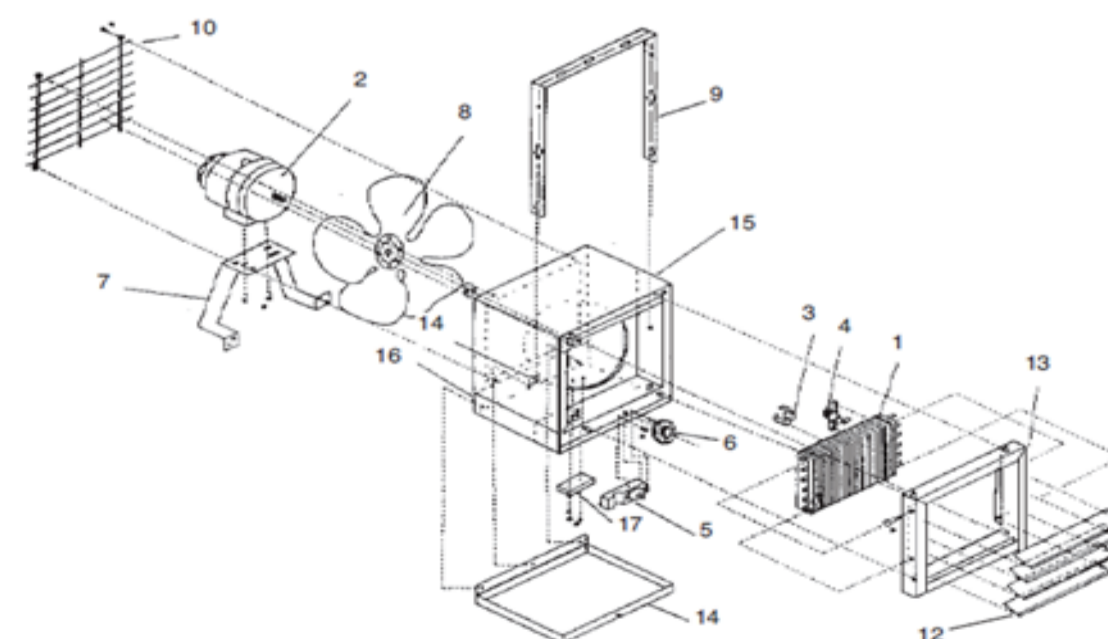

FOR SERVICE PARTS CONTACT CARROLL PARTS 800-654-3545

**C2500 & 2500 SERIES
ELEMENTS**

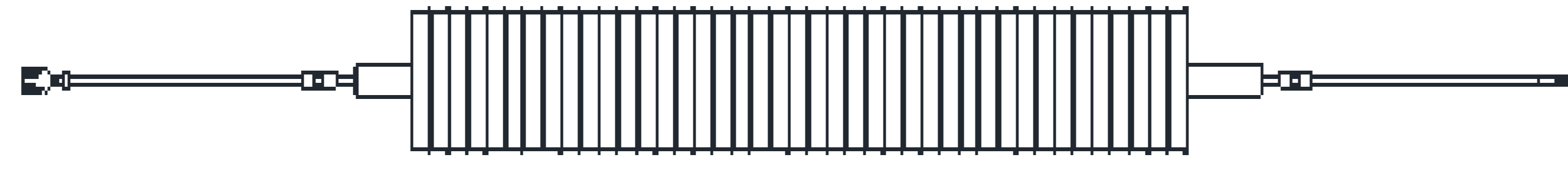

1802-11021-008 2573WCA 2573NWCA C2573WCA C2573NWCA	1802-11021-009 2543WCA 2543NWCA C2543WCA C2543NWCA	1802-11021-010 2503WCA 2503NWCA C2503WCA C2503NWCA	1802-11021-011 2513WCA 2513NWCA C2513WCA C2513NWCA	1802-2044-014 2574WCA 2574NWCA C2574WCA C2574NWCA	1802-2044-015 2544WCA 2544NWCA C2544WCA C2544NWCA
1802-2044-026 2576WCA 2576NWCA C2576WCA C2576NWCA	1802-2094-017 2546WCSA 2546NWCSA C2546WCSA C2546NWCSA	1802-2044-028 2506WCA 2506NWCA C2506WCA C2506NWCA	1802-2094-015 2516WCSA 2516NWCSA C2516WCSA C2516NWCSA	1802-2044-016 2504WCA 2504NWCA C2504WCA C2504NWCA	1802-2044-017 2514WCA 2514NWCA C2514WCA C2514NWCA
1802-2044-020 2575WCA 2575NWCA C2575WCA C2575NWCA	1802-2044-021 2545WCA 2545NWCA C2545WCA C2545NWCA	1802-2044-022 2505WCA 2505NWCA C2505WCA C2505NWCA	1802-2044-023 2515WCA 2515NWCA C2515WCA C2515NWCA	1802-2094-000 2508WCSA 2508NWCSA C2508WCSA C2508NWCSA	1802-2094-001 2548WCSA 2548NWCSA C2548WCSA C2548NWCSA
1802-11021-000 2572WCA 2572NWCA C2572WCA C2572NWCA	1802-11021-001 2542WCA 2542NWCA C2542WCA C2542NWCA	1802-11021-002 2502WCA 2502NWCA C2502WCA C2502NWCA	1802-11021-003 2512WCA 2512NWCA C2512WCA C2512NWCA	1802-2094-002 2578WCSA 2578NWCSA C2578WCSA C2578NWCSA	1802-2094-003 25008WCSA 25008NWCSA C25008WCSA C25008NWCSA
1802-11021-004 25726WCA 25726NWCA C25726WCA C25726NWCA	1802-11021-005 25426WCA 25426NWCA C25426WCA C25426NWCA	1802-11021-006 25026WCA 25026NWCA C25026WCA C25026NWCA	1802-11021-007 25126WCA 25126NWCA C25126WCA C25126NWCA	1802-2094-004 25408WCSA 25408NWCSA C25408WCSA C25408NWCSA	1802-2094-005 25708WCSA 25708NWCSA C25708WCSA C25708NWCSA

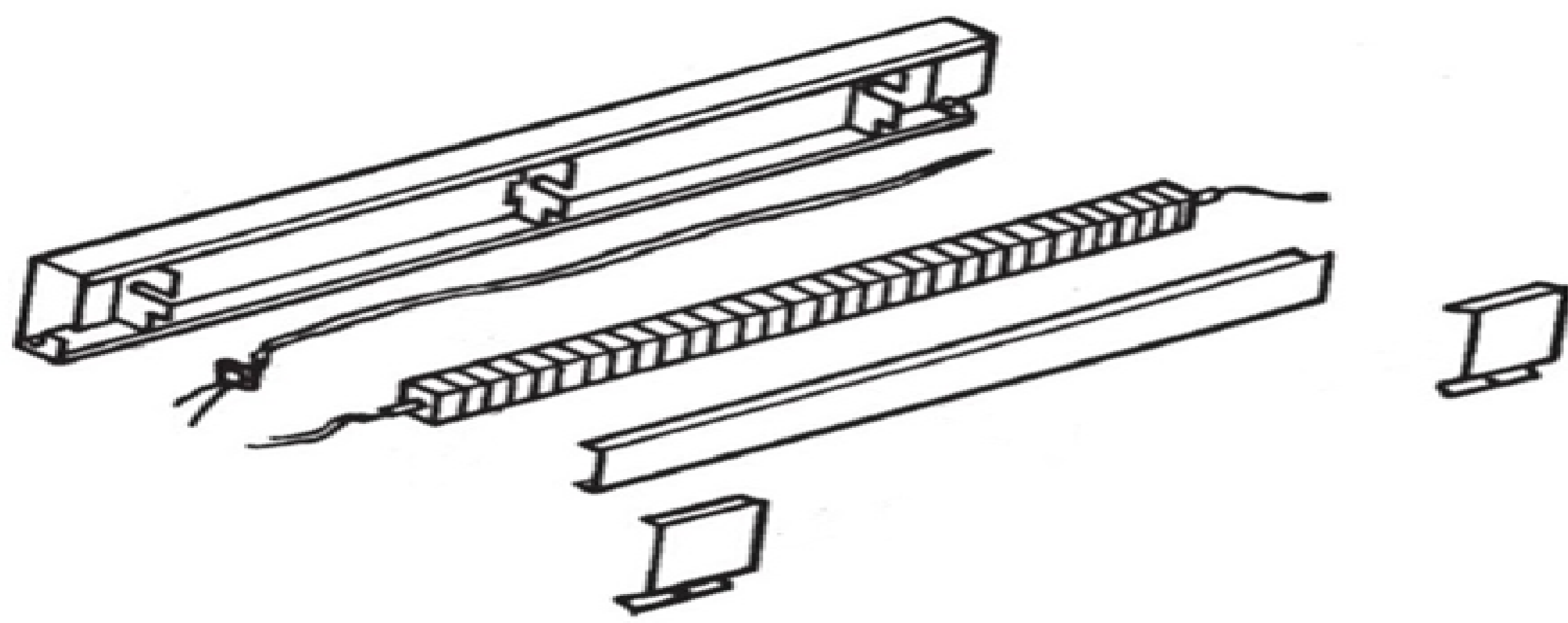

C2500 & 2500 SERIES CONTINUED

THERMAL CUTOUT



4520-2018-000		4520-2018-001		4520-2018-002		4520-2018-003		4520-2018-004	
2512NWC	2512WC	25126NWC	25126WC	2513NWC	2513WC	2514NWC	2514WC	2515NWC	2515WC
2512NWCA	2512WCA	25126NWCA	25126WCA	2513NWCA	2513WCA	2514NWCA	2514WCA	2515NWCA	2515WCA
2502NWC	2502WC	25026NWC	25026WC	2503NWC	2503WC	2504NWC	2504WC	2505NWC	2505WC
2502NWCA	2502WCA	25026NWCA	25026WCA	2503NWCA	2503WCA	2504NWCA	2504WCA	2505NWCA	2505WCA
2542NWC	2542WC	25426NWC	25426WC	2543NWC	2543WC	2544NWC	2544WC	2545NWC	2545WC
2542NWCA	2542WCA	25426NWCA	25426WCA	2543NWCA	2543WCA	2544NWCA	2544WCA	2545NWCA	2545WCA
2572NWC	2572WC	25726NWC	25726WC	2573NWC	2573WC	2574NWC	2574WC	2575NWC	2575WC
2572NWCA	2572WCA	25726NWCA	25726WCA	2573NWCA	2573WCA	2574NWCA	2574WCA	2575NWCA	2575WCA
C2512NWC	C2512WC	C25126NWC	C25126WC	C2513NWC	C2513WC	C2514NWC	C2514WC	C2515NWC	C2515WC
C2502NWC	C2512WCA	C25026NWC	C25126WCA	C2503NWC	C2513WCA	C2504NWC	C2514WCA	C2505NWC	C2515WCA
C2542NWC	C2502WC	C25426NWC	C25026WC	C2543NWC	C2503WC	C2544NWC	C2504WC	C2545NWC	C2505WC
C2572NWC	C2502WCA	C25726NWC	C25026WCA	C2573NWC	C2503WCA	C2574NWC	C2504WCA	C2575NWC	C2505WCA
	C2542WC		C25426WC		C2543WC		C2544WC		C2545WC
	C2542WCA		C25426WCA		C2543WCA		C2544WCA		C2545WCA
	C2572WC		C25726WC		C2573WC		C2574WC		C2575WC
	C2572WCA		C25726WCA		C2573WCA		C2574WCA		C2575WCA
4520-2018-005		4520-2018-006		4520-2019-000		4520-2019-001		4520-2019-002	
2516NWC	2516WC	2508NWC	2508WC	2512HNWC	2512HWC	25126HNWC	25126HWC	2513HNWC	2513HWC
2516NWCA	2516WCA	2508NWCA	2508WCA	2512HNWCA	2512HWCA	25126HNWCA	25126HWCA	2513HNWCA	2513HWCA
2506NWC	2506WC	25008NWC	25008WC	2502HNWC	2502HWC	25026HNWC	25026HWC	2503HNWC	2503HWC
2506NWCA	2506WCA	25008NWCA	25008WCA	2502HNWCA	2502HWCA	25026HNWCA	25026HWCA	2503HNWCA	2503HWCA
2546NWC	2546WC	2548NWC	2548WC	2542HNWC	2542HWC	25426HNWC	25426HWC	2543HNWC	2543HWC
2546NWCA	2546WCA	2548NWCA	2548WCA	2542HNWCA	2542HWCA	25426HNWCA	25426HWCA	2543HNWCA	2543HWCA
2546NWC	2546WCS	2548NWC	2548WCS	2572HNWC	2572HWC	25726HNWC	25726HWC	2573HNWC	2573HWC
2546NWCA	2546WCSA	2548NWCA	2548WCSA	2572HNWCA	2572HWCA	25726HNWCA	25726HWCA	2573HNWCA	2573HWCA
2576NWC	2576WC	25408NWC	25408WC				C25126HWC		C2513HWC
2576NWCA	2576WCA	25408NWCA	25408WCA				C25126HWCA		C2513HWCA
C2516NWC	C2516WC	25408NWC	25408WCS				C25026HWC		C2503HWC
C2506NWC	C2516WCA	25408NWCA	25408WCSA				C25026HWCA		C2503HWCA
C2546NWC	C2506WC	2578NWC	2578WC				C25426HWC		C2543HWC
C2576NWC	C2506WCA	2578NWCA	2578WCA				C25426HWCA		C2543HWCA
	C2546WC	25708NWC	25708WC				C25726HWC		C2573HWC
	C2546WCA	25708NWCA	25708WCA				C25726HWCA		C2573HWCA
	C2576WC	C2508NWC	C2508WC						
	C2576WCA	C2508NWCA	C2508WCA						
		C2548NWC	C2508WC						
		C2548NWCA	C2508WCA						
		C25408NWC	C2508WCA						
		C2578NWC	C2548WC						
		C2578NWCA	C2548WCA						
		C25708NWC	C25408WC						
		C25708NWCA	C25408WCA						
			C25408WC						
			C25408WCA						
			C2578WC						
			C2578WCA						
			C25708WC						
			C25708WCA						
4520-2019-005		4520-2019-006		4520-2019-003		4520-2019-004			
2516HNWC	2516HWC	2508HNWC	2508HWC	2514HNWC	2514HWC	2515HNWC	2515HWC		
2516HNWCA	2516HWCA	2508HNWCA	2508HWCA	2514HNWCA	2514HWCA	2515HNWCA	2515HWCA		
2506HNWC	2506HWC	25008HNWC	25008HWC	2504HNWC	2504HWC	2505HNWC	2505HWC		
2506HNWCA	2506HWCA	25008HNWCA	25008HWCA	2504HNWCA	2504HWCA	2505HNWCA	2505HWCA		
2546HNWC	2546HWC	2548HNWC	2548HWC	2544HNWC	2544HWC	2545HNWC	2545HWC		
2546HNWCA	2546HWCA	2548HNWCA	2548HWCA	2544HNWCA	2544HWCA	2545HNWCA	2545HWCA		
2576HNWC	2576HWC	25408HNWC	25408HWC	2574HNWC	2574HWC	2575HNWC	2575HWC		
2576HNWCA	2576HWCA	25408HNWCA	25408HWCA	2574HNWCA	2574HWCA	2575HNWCA	2575HWCA		
	C2516HWC	2578HNWC	2578HWC		C2514HWC		C2515HWC		
	C2516HWCA	2578HNWCA	2578HWCA		C2514HWCA		C2515HWCA		
	C2506HWC	25708HNWC	25708HWC		C2504HWC		C2505HWC		
	C2506HWCA	25708HNWCA	25708HWCA		C2504HWCA		C2505HWCA		
	C2546HWC		C2508HWC		C2544HWC		C2545HWC		
	C2546HWCA		C2508WCA		C2544HWCA		C2545HWCA		
	C2576HWC		C25008HWC		C2574HWC		C2575HWC		
	C2576HWCA		C25008WCA		C2574HWCA		C2575HWCA		
			C2548HWC						
			C2548HWCA						
			C25408HWC						
			C25408HWCA						
			C2578HWC						
			C2578HWCA						
			C25708HWC						
			C25708HWCA						

C2500 & 2500 SERIES CONTINUED

FACE PLATE



COLOR	FEET	GA.	PART NUMBER	COLOR	FEET	GA.	PART NUMBER
NAVAJO	2.5	18	1402-2122-040	NORTHERN WHITE	2.5	18	1402-2122-061
NAVAJO	3	18	1402-2122-041	NORTHERN WHITE	3	18	1402-2122-062
NAVAJO	4	18	1402-2122-042	NORTHERN WHITE	4	18	1402-2122-063
NAVAJO	5	18	1402-2122-043	NORTHERN WHITE	5	18	1402-2122-064
NAVAJO	6	18	1402-2122-044	NORTHERN WHITE	6	18	1402-2122-065
NAVAJO	8	18	1402-2122-045	NORTHERN WHITE	8	18	1402-2122-066
NAVAJO	2	22	1402-2122-635	NORTHERN WHITE	2	22	1402-2122-623
NAVAJO	2.5	22	1402-2122-628	NORTHERN WHITE	2.5	22	1402-2122-616
NAVAJO	3	22	1402-2122-629	NORTHERN WHITE	3	22	1402-2122-617
NAVAJO	4	22	1402-2122-630	NORTHERN WHITE	4	22	1402-2122-618
NAVAJO	5	22	1402-2122-631	NORTHERN WHITE	5	22	1402-2122-619
NAVAJO	6	22	1402-2122-632	NORTHERN WHITE	6	22	1402-2122-620
NAVAJO	8	22	1402-2122-633	NORTHERN WHITE	8	22	1402-2122-621

NOTE: 18GA IS FOR COMERCIAL MODELS

CONTROL BOX COVER











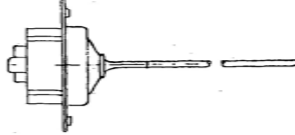

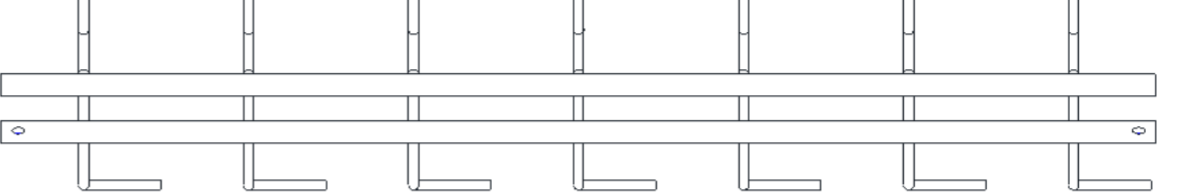
COLOR	GA.	PART NUMBER	COLOR	GA.	PART NUMBER
NAVAJO	24	1402-2261-601	NORTHERN WHITE	24	1402-2261-600
NAVAJO	20	1402-2261-603	NORTHERN WHITE	20	1402-2261-604

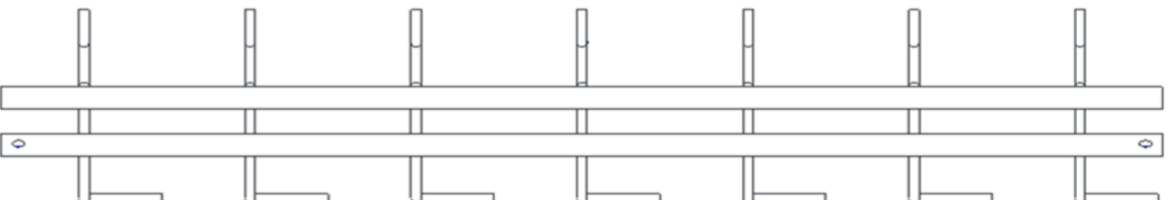

NOTE: 20 GA IS FOR COMERCIAL MODELS

ACCESSORIES

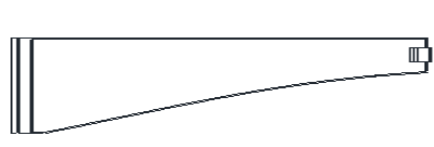
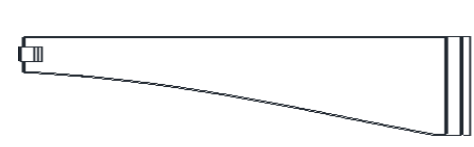
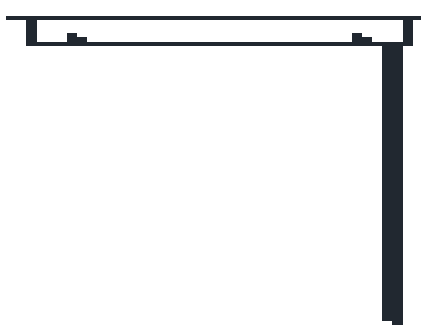
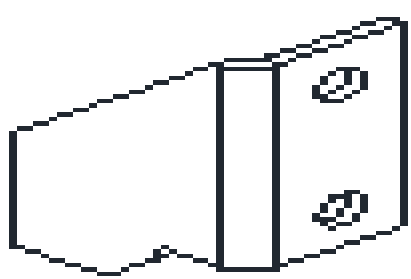
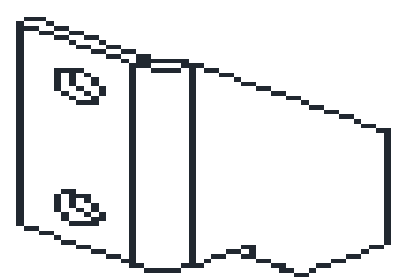
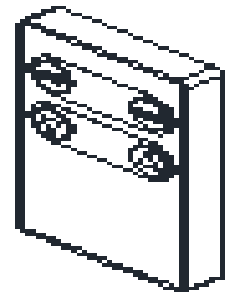
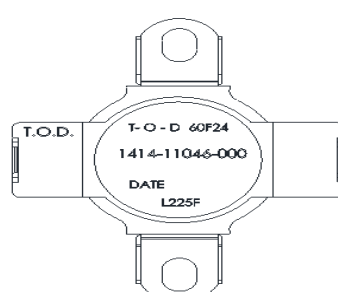
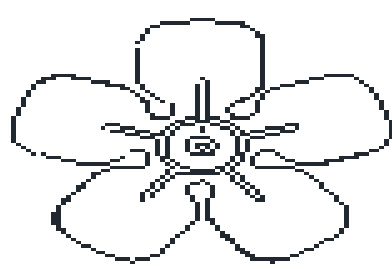
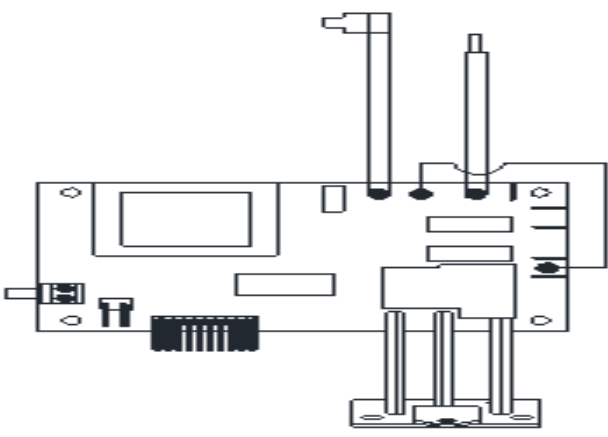
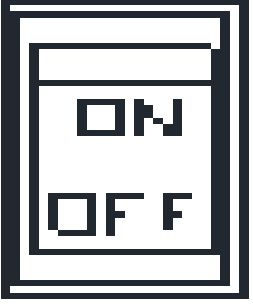
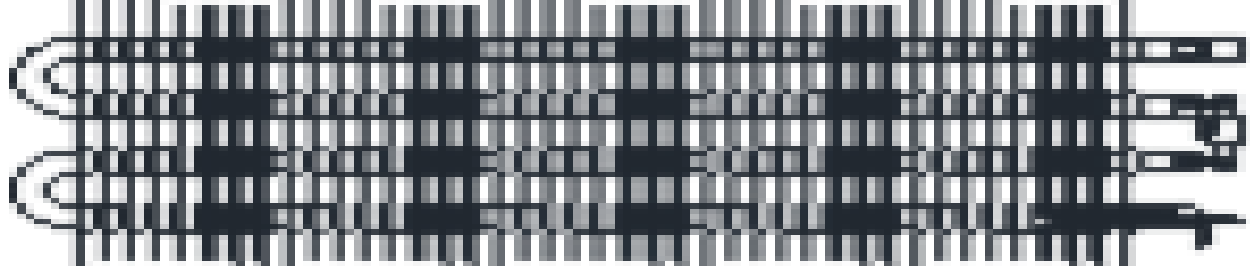
MODEL	KNOBS	THERMOSTATS
T1	3301-2011-000	5813-2014-000
T2	3301-2011-000	5813-2015-000
T1A	3301-2014-006	410127001
T2A	3301-2020-004	410128001
T4		410129001
T4A	3301-2014-006	410129001
T5A	3301-2020-004	410130001
TA1AW	42521-032-10	5813-2009-000
TA2AW	42521-032-08	5813-2010-000
TA1ANW	42521-032-11	5813-2009-000
TA2ANW	42521-032-09	5813-2010-000
TA1AWCA	42521-032-10	5813-2009-000
TA2AWCA	42521-032-08	5813-2010-000
TA1ANWCA	42521-032-11	5813-2009-000
TA2ANWCA	42521-032-09	5813-2010-000

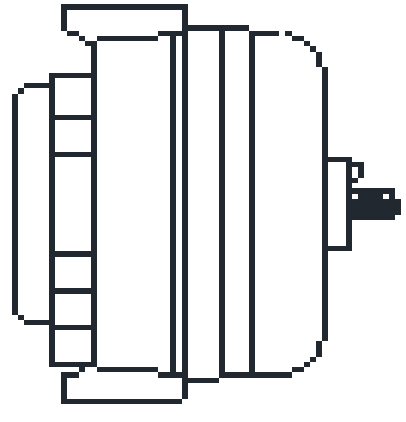
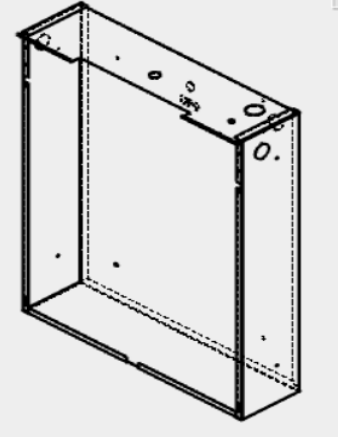

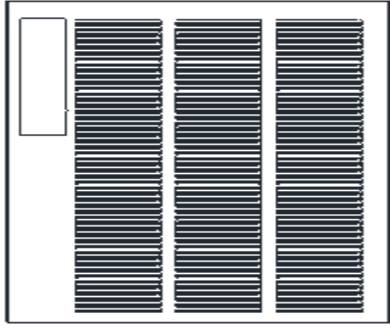

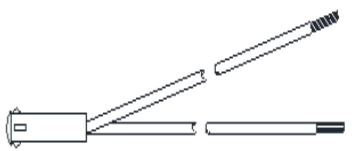
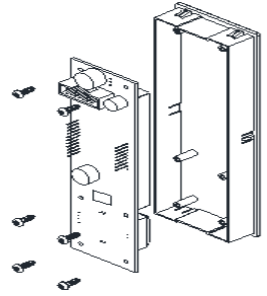
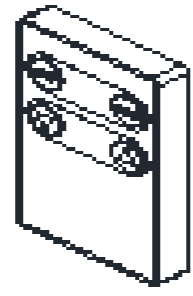
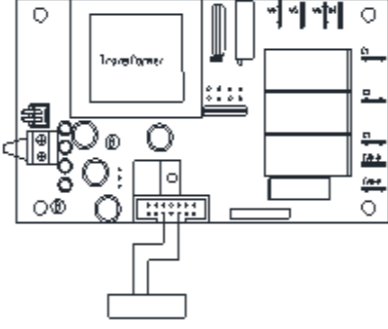
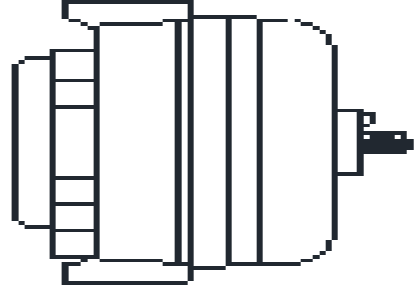
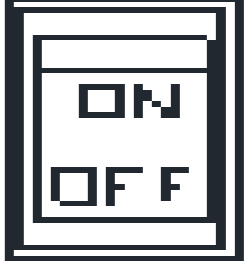
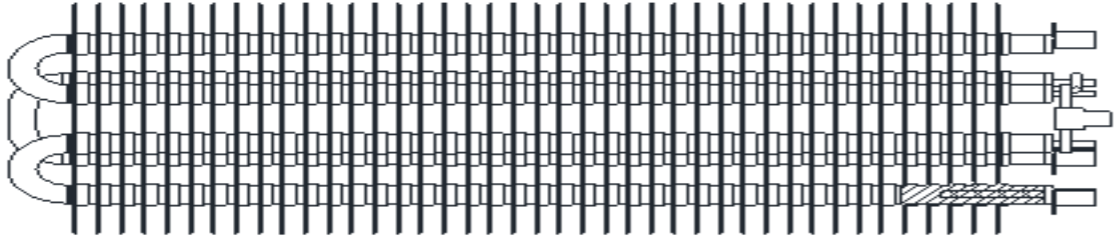
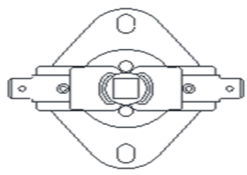
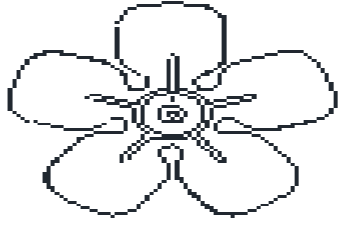
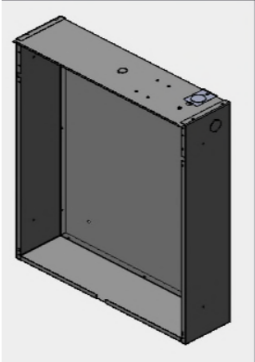

HBB SERIES BASEBOARD											
ELEMENT						LIMIT					
REPLACE HEATER IF ELEMENT NEEDS TO BE REPLACED											
						410122002 500D 500DA 500DB 504D 504DA 504DB 508D 508DA 508DB	410122003 7500D 7500DA 7500DB 7504D 7504DA 7504DB 7507D 7508D 7508DA 7508DB	410122004 1000D 1000DA 1000DB 1004D 1004DA 1004DB 1007D 1008D 1008DA 1008DB	410122005 1250D 1250DA 1250DB 1254D 1254DA 1254DB 1257D 1258D 1258DA 1258DB	410122006 1500D 1500DA 1500DB 1504D 1504DA 1504DB 1507D 1508D 1508DA 1508DB	410122008 2004D 2004DA 2004DB 2007D 2008D 2008DA 2008DB
FRONT COVER						GRILLE					
											
1402-2066-600 500D 500DA 500DB 504D 504DA 504DB 508D 508DA 508DB	1402-2066-601 7500D 7500DA 7500DB 7504D 7504DA 7504DB 7507D 7508D 7508DA 7508DB	1402-2066-602 1000D 1000DA 1000DB 1004D 1004DA 1004DB 1007D 1008D 1008DA 1008DB	1402-2066-603 1250D 1250DA 1250DB 1254D 1254DA 1254B 1257D 1258D 1258DA 1258DB	1402-2066-604 1500D 1500DA 1500DB 1504D 1504DA 1504DB 1507D 1508D 1508DA 1508DB	1402-2066-605 2004D 2004DA 2004DB 2007D 2008D 2008DA 2008DB	2501-2012-012 500D 500DA 500DB 504D 504DA 504DB 508D 508DA 508DB	2501-2012-013 7500D 7500DA 7500DB 7504D 7504DA 7504DB 7507D 7508D 7508DA 7508DB	2501-2012-014 1000D 1000DA 1000DB 1004D 1004DA 1004DB 1007D 1008D 1008DA 1008DB	2501-2012-015 1250D 1250DA 1250DB 1254D 1254DA 1254DB 1257D 1258D 1258DA 1258DB	2501-2012-010 1500D 1500DA 1500DB 1504D 1504DA 1504DB 1507D 1508D 1508DA 1508DB	2501-2012-011 2004D 2004DA 2004DB 2007D 2008D 2008DA 2008DB
JUNCTION BOX COVER ALL MODELS 1800-2022-000											
											
OBD SERIES BASEBOARD (OBSOLETE)											
ELEMENT						LIMIT					
											
1802-2056-007 D500 D500A	1802-2056-011 D750 D750A	1802-2063-017 D1000 D1000A	1802-2063-023 D1250 D1250A	1802-2094-015 D1500 D1500A	1802-2063-033 D2004 D2004A	4520-2018-001 D500 D500A	4520-2018-002 D750 D750A	4520-2018-003 D1000 D1000A	4520-2018-004 D1250 D1250A	4520-2018-005 D1500 D1500A	4520-2018-006 D2004 D2004A
1802-2056-005 D504 D504A	1802-2056-009 D754 D754A	1802-2063-015 D1004 D1004A	1802-2063-021 D1254 D1254A	1802-2063-027 D1504 D1504A	1802-2063-032 D2007 D2007A	4520-2018-001 D504 D507	4520-2018-002 D754 D757	4520-2018-003 D1004 D1007	4520-2018-004 D1254 D1256	4520-2018-005 D1504 D1507	4520-2018-006 D2007 D2008
1802-2056-004 D507 D507A	1802-2056-008 D757 D757A	1802-2063-014 D1007 D1007A	1802-2063-047 D1256 D1256A	1802-2063-026 D1507 D1507A	1802-2063-034 D2008 D2008A	4520-2018-001 D508 D508A	4520-2018-002 D758 D758A	4520-2018-003 D1008 D1008A	4520-2018-004 D1257 D1257A D1258 D1258A	4520-2018-005 D1508 D1508A	4520-2018-006 D2008A
1802-2056-006 D508 D508A	1802-2056-010 D758 D758A	1802-2063-016 D1008 D1008A	1802-2063-020 D1257 D1257A D1258 D1258A	1802-2063-028 D1508 D1508A							
FRONT COVER						GRILLE					
											
1402-2066-010 D500 D500A D504 D504A D507 D507A D508 D508A	1402-2066-011 D750 D750A D754 D754A D757 D757A D758 D758A	1402-2066-012 D1000 D1000A D1004 D1004A D1007 D1007A D1008 D1008A	1402-2066-013 D1250 D1250A D1254 D1254A D1256 D1256A D1257 D1257A D1258 D1258A	1402-2066-014 D1500 D1500A D1504 D1504A D1507 D1507A D1508 D1508A	1402-2066-015 D2004 D2004A D2007 D2007A D2008 D2008A	2501-2012-012 D500 D500A D504 D504A D507 D507A D508 D508A	2501-2012-013 D750 D750A D754 D754A D757 D757A D758 D758A	2501-2012-014 D1000 D1000A D1004 D1004A D1007 D1007A D1008 D1008A	2501-2012-015 D1250 D1250A D1254 D1254A D1256 D1256A D1257 D1257A D1258 D1258A	2501-2012-010 D1500 D1500A D1504 D1504A D1507 D1507A D1508 D1508A	2501-2012-011 D2004 D2004A D2007 D2007A D2008 D2008A
JUNCTION BOX COVER ALL MODELS 1800-2022-000											
											
SEE ACCESSORIES ON 2500 SERIES PAGE FOR T1 & T2 THERMOSTAT PARTS											



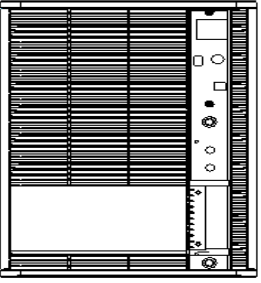

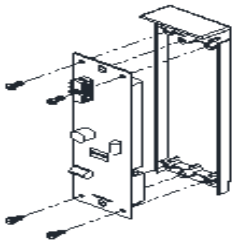
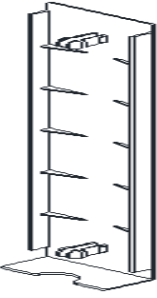

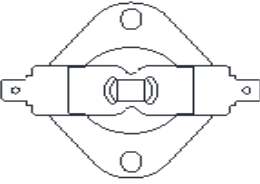
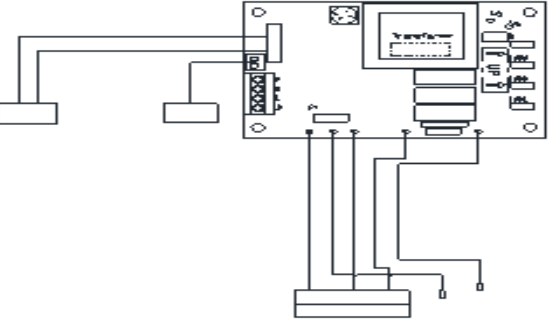
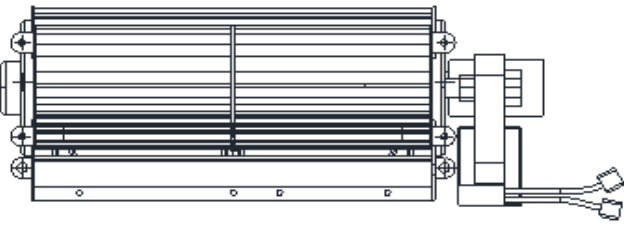
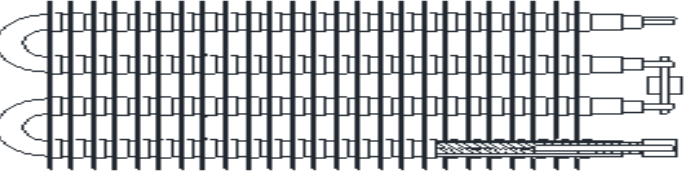
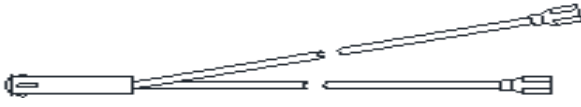



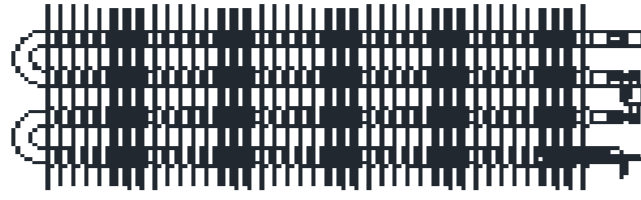

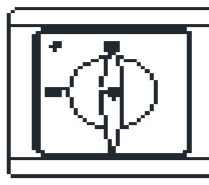
ARWH SERIES							
RIGHT BEZEL	LEFT BEZEL	DISPLAY ASSM.	BOTTOM BRACKET LT.	BOTTOM BRACKET RT.	REMOTE	EOL LIMIT	FAN BLADE
							
1219-11009-001 ALL MODELS	1219-11009-000 ALL MODELS	1016-11188-000 ALL MODELS	1215-11070-000 ALL MODELS	1215-11070-001 ALL MODELS	1414-11037-001 ALL MODELS	1414-11046-000 ALL MODELS	490030103 ALL MODELS
PWR CONTROL BOARD			DISCONNECT SWITCH	ELEMENT			
							
1414-11033-002 ARWH1802 ARWH1802AL ARWH1802BZ ARWH1802W	1414-11033-001 ARWH4807 ARWH4807AL ARWH4807BZ ARWH4807W	1414-11033-000 ARWH4808 ARWH4804 ARWH4808AL ARWH4804AL ARWH4808BZ ARWH4804BZ ARWH4808W ARWH4804W	410170001 ARWH1802 ARWH1802AL ARWH1802BZ ARWH1802W ARWH4804 ARWH4804AL ARWH4804BZ ARWH4804W ARWH4807 ARWH4807AL ARWH4807BZ ARWH4807W	302012828 ARWH1802 ARWH1802AL ARWH1802BZ ARWH1802W	1802-2075-801 ARWH4808 ARWH4808AL ARWH4808BZ ARWH4808W	302012810 ARWH4804 ARWH4804AL ARWH4804BZ ARWH4804W	302012811 ARWH4807 ARWH4807AL ARWH4807BZ ARWH4807W
MOTOR			BACK BOX	PARTS KIT			
							
3900-11026-002 ARWH1802 ARWH1802AL ARWH1802BZ ARWH1802W	3900-11026-001 ARWH4807 ARWH4807AL ARWH4807BZ ARWH4807W	3900-11026-000 ARWH4808 ARWH4804 ARWH4808AL ARWH4804AL ARWH4808BZ ARWH4804BZ ARWH4808W ARWH4804W	1203-11011-000 ALL MODELS	1205-11023-000 ALL MODELS			



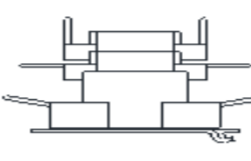

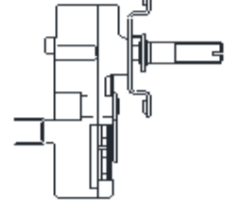
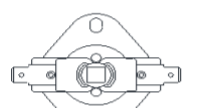

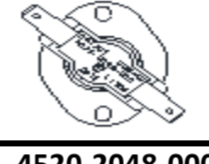
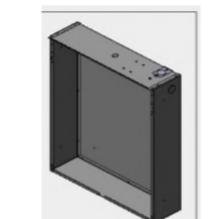

SSHO SERIES						
GRILLE			GRILLE TABS (2 REQ)			LIGHT
						
2501-11022-000 HOSS4004 HOSS4007 HOSS4008	2501-11022-001 HOSS4004SB HOSS4007SB HOSS4008SB	2501-11022-002 HOSS4004NV HOSS4007NV HOSS408NV	1402-2120-002 HOSS4004 HOSS4007 HOSS4008	1402-2120-001 HOSS4004SB HOSS4007SB HOSS4008SB	1402-2120-000 HOSS4004NV HOSS4007NV HOSS408NV	3510-2017-005 ALL MODELS
DISPLAY ASSM.	REMOTE	CTRL PWR BOARD		MOTOR		DISCONNECT SWITCH
						
1016-11199-000 ALL MODELS	1414-11037-001 ALL MODELS	1414-11043-000 HOSS4004 HOSS4004NV HOSS4004SB HOSS4008 HOSS408NV HOSS4008SB	1414-11043-001 HOSS4007 HOSS4007NV HOSS4007SB	3900-2002-522 HOSS4004 HOSS4004NV HOSS4004SB HOSS4008 HOSS408NV HOSS4008SB	3900-2002-523 HOSS4007 HOSS4007NV HOSS4007SB	410170001 ALL MODELS
ELEMENT			MANUAL LIMIT	FAN BLADE	BACK BOX	PARTS KIT
						
1802-11005-000 HOSS4008 HOSS408NV HOSS4008SB	1802-11005-001 HOSS4004 HOSS4004NV HOSS4004SB	1802-11005-002 HOSS4007 HOSS4007NV HOSS4007SB	4520-2027-000 ALL MODELS	490030103 ALL MODELS	1016-11242-000 ALL MODELS	1205-2020-002 ALL MODELS

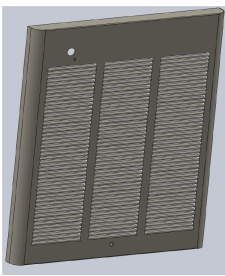
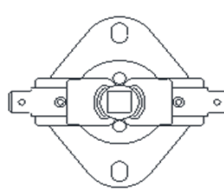

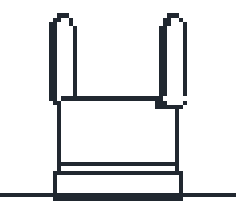
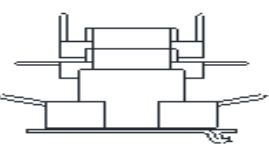

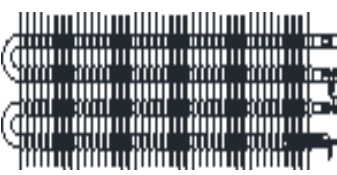
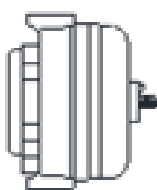

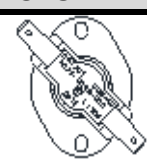

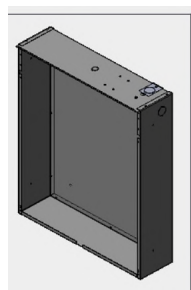

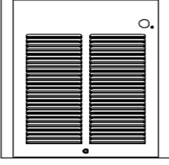

HT SMART SERIES





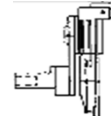

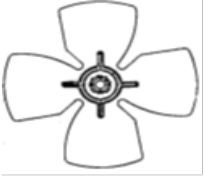

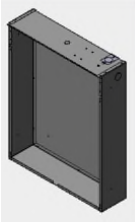



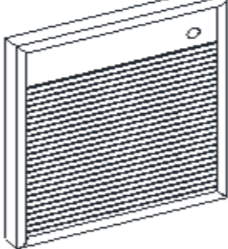
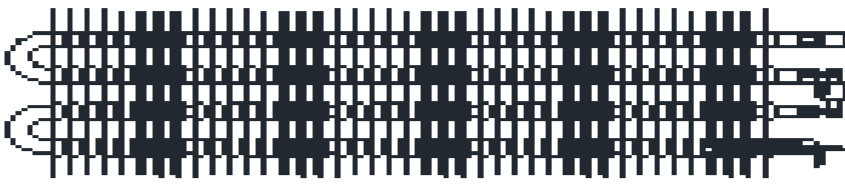

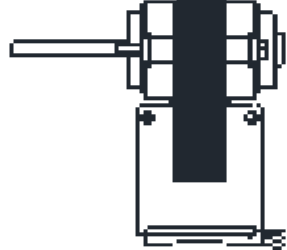
GRILLE PANEL		GRILLE ASSY INSERT		DISPLAY BEZEL	BOTTOM BEZEL	REMOTE	MANUAL LIMIT
							
2501-11003-003 HT1502SS HT2024SS	2501-11003-004 HT1502SSNW HT2024SSNW	1016-11063-000 HT1502SS HT2024SS	1016-11063-001 HT1502SSNW HT2024SSNW	1016-11035-003 HT1502SS HT2024SS HT1502SSNW HT2024SSNW	1219-11004-000 ALL MODELS	1414-11017-001 ALL MODELS	4520-11005-000 ALL MODELS
CNTRL PWR BOARD		BLOWER MOTOR		ELEMENT		LIGHT	
							
1414-11007-002 HT1502SS HT1502SSNW	1414-11007-003 HT2024SS HT2024SSNW	1225-11001-000 HT1502SS HT1502SSNW	1225-11001-001 HT2024SS HT2024SSNW	302023802 HT1502SS HT1502SSNW	302023805 HT2024SS HT2024SSNW	3510-2010-000 HT1502SS HT1502SSNW	3510-2010-001 HT2024SS HT2024SSNW
BACK BOX	PARTS KIT						
1016-11032-000 ALL MODELS	1205-11010-000 ALL MODELS						

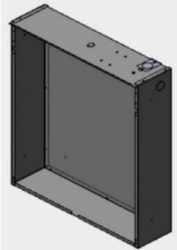

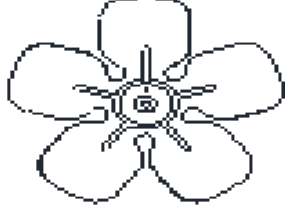
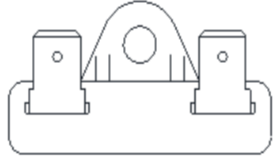

WH-FC SERIES (FRC)												
GRILLE				ELEMENTS				DISCONNECT SWITCH				
												
1016-11225-000 WH3150FC WH3180FC WH4303FC WH4306FC WH4307FC WH4404FC WH44043FC WH4407FC WH4408FC		1016-11225-001 WH3150FCNW WH3180FCNW WH4303FCNW WH4306FCNW WH4307FCNW WH4404FCNW WH44043FCNW WH4407FCNW WH4408FCNW		302012806 WH4307FC WH4307FCNW	302012809 WH4407FC WH4407FCNW	302012810 WH4504FC WH4504FCNW	1802-2075-802 WH44043FC WH44043FCNW WH44083FC WH44083FCNW	410170001 WH3150FC WH3150FCNW WH3180FC WH3180FCNW WH4307FC WH4307FCNW WH4404FC WH4404FCNW		5216-2019-000 WH4303FC WH4303FCNW WH4306FC WH4306FCNW WH44043FC WH44043FCNW WH44043FCNW WH44083FC WH44083FCNW WH4503FC WH4503FCNW		
MOTOR				FAN DELAY				RELAY		TRANSFORMER		
												
3900-2010-000 WH4303FC WH4303FCNW WH4306FC WH4306FCNW WH4404FC WH4404FCNW WH4408FC		3900-2010-001 WH4507NW WH4307FC WH4307FCNW WH4407FC WH4407FCNW WH4507FC WH4507FCNW	3900-2010-003 WH3150FC WH3150FCNW WH3180FC WH3180FCNW	3900-2002-518 WH44043FC WH44043FCNW WH44083FC WH44083FCNW WH45043FC WH45043FCNW WH4508FC WH4508FCNW WH45083FC WH45083FCNW	410074000 WH3150FC WH3150FCNW WH3180FC WH3180FCNW WH4303FC WH4303FCNW WH4303FCNW WH4306FC WH4306FCNW WH4307FC WH4307FCNW WH4404FC WH4404FCNW WH4507FC WH4507FCNW		4520-2024-000 WH44043FC WH44043FCNW WH44083FC WH44083FCNW WH45043FC WH45043FCNW WH4508FC WH4508FCNW WH45083FC WH45083FCNW		410101002 WH44043FC WH44043FCNW WH45043FC WH45043FCNW		490015017 WH4303FC WH4303FCNW WH4503FC WH4503FCNW	490015013 WH4306FC WH4306FCNW WH4506FC WH4506FCNW
THERMOSTAT 	MANUAL LIMIT 	FAN BLADE 	RELAY FOR MODELS OLDER THAN MARCH 2020 				AUTO LIMIT 	BACK BOX 				
410168002 1 PHASE MODELS	4520-2027-000 ALL MODELS	490030103 ALL MODELS					5018-2017-000 WH44043FC WH44043FCNW WH45043FC WH45043FCNW	5018-2017-004 WH44083FC WH44083FCNW WH4508FC WH4508FCNW WH45083FC WH45083FCNW	4520-2048-000 WH44043FC WH44043FCNW WH44083FC WH44083FCNW WH45043FC WH45043FCNW WH4508FC WH4508FCNW WH45083FC WH45083FCNW		1016-11243-500 ALL MODELS	
THERMOSTAT 5813-2027-001 3 PHASE MODELS & WH4508FC												





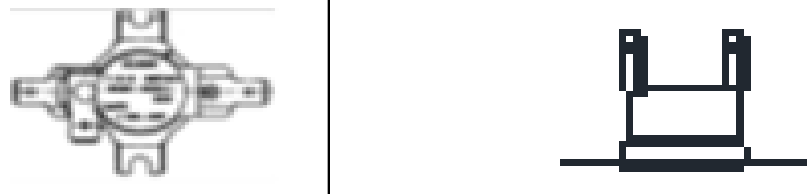
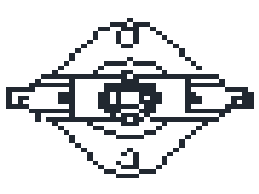
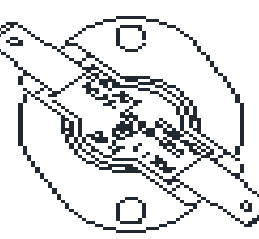
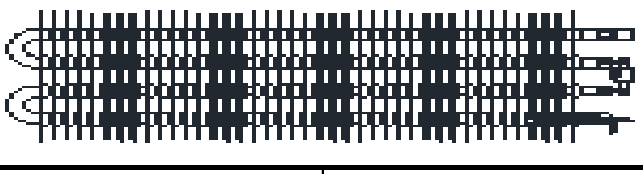
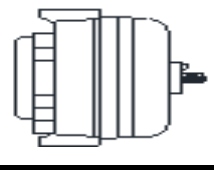
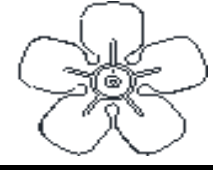
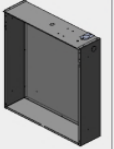
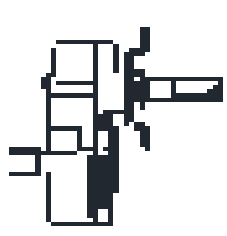
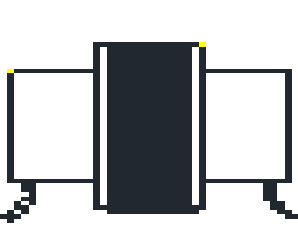
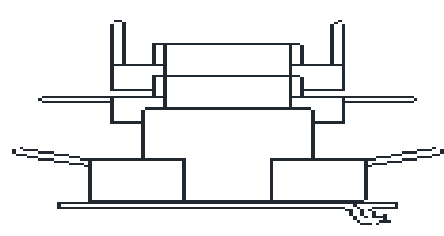
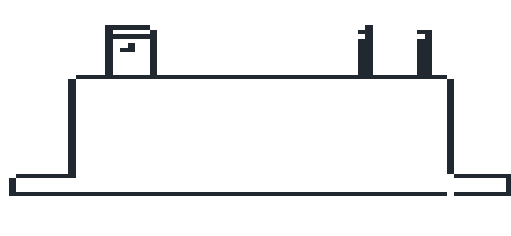

WHB (FRA-F)					
GRILLE	MANUAL LIMIT	FAN BLADE	THERMOSTAT	FAN DELAY	RELAY
					
1016-11226-000 WHB3150FC WHB3180FC WHB3307FC WHB3404FC WHB34043FC WHB3407FC WHB3408FC WHB34083FC WHB3504FC WHB35043FC WHB3507FC WHB3508FC WHB35083FC	4520-2027-000 WHB3150FC WHB3180FC WHB3307FC WHB3404FC WHB34043FC WHB3407FC WHB3408FC WHB34083FC WHB3504FC WHB35043FC WHB3507FC WHB3508FC WHB35083FC	490030103 WHB3150FC WHB3180FC WHB3307FC WHB3404FC WHB34043FC WHB3407FC WHB3408FC WHB34083FC WHB3504FC WHB35043FC WHB3507FC WHB3508FC WHB35083FC	5813-2059-000 WHB3150FC WHB3180FC WHB3307FC WHB3404FC WHB34043FC WHB3407FC WHB3408FC WHB34083FC WHB3504FC WHB35043FC WHB3507FC WHB3508FC WHB35083FC	410074000 WHB3150FC WHB3180FC WHB3307FC WHB3404FC WHB34043FC WHB3407FC WHB3408FC WHB34083FC WHB3504FC WHB35043FC WHB3507FC WHB3508FC WHB35083FC	410101002 WHB34043FC WHB35043FC WHB34083FC WHB3508FC WHB35083FC
DISCONNECT SWITCH		ELEMENT		MOTOR	
					
410170001 WHB3150FC WHB3180FC WHB3307FC WHB3404FC WHB3407FC WHB3408FC WHB3504FC WHB3507FC	5216-2019-000 WHB34043FC WHB34083FC WHB35043FC WHB3508FC WHB35083FC	302012827 WHB3150FC 302012807 WHB3408FC 302012828 WHB3180FC 302012806 WHB3307FC 302012808 WHB3404FC 302012809 WHB3407FC 302012810 WHB3504FC	302012811 WHB3507FC 1802-2075-800 WHB34083FC 1802-2075-801 WHB3508FC WHB35083FC 1802-2075-802 WHB34043FC 1802-2075-803 WHB35043FC	3900-2010-003 WHB3150FC WHB3180FC 3900-2010-001 WHB3307FC WHB3507FC WHB3407FC 3900-2010-000 WHB3404FC WHB3408FC WHB3504FC	3900-2002-518 WHB34043FC WHB34083FC WHB35043FC WHB3508FC WHB35083FC 
AUTO LIMIT	RELAY MODELS BEFORE 2020		BACK BOX		
					
4520-2048-000 WHB34043FC WHB35043FC WHB34083FC WHB3508FC WHB35083FC	5018-2017-000 WHB34043FC WHB35043FC	5018-2017-004 WHB34083FC WHB3508FC WHB35083FC	1016-11243-500 ALL MODELS		
PARTS KIT P/N 1205-11031-001 (KNOB, GRILLE SCREWS, AND PLUG BUTTONS)					

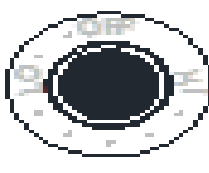
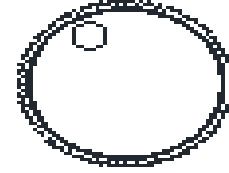

WHB SERIES (SRA)

WHB SERIES (SRA)					
GRILLE	KNOB	ELEMENT		MOTOR	
					
1016-11228-000 WHB1101FC WHB1151FC WHB1157FC WHB1201FC WHB1202FC WHB1207FC WHB1208FC	3301-11015-001 WHB1101FC WHB1151FC WHB1157FC WHB1201FC WHB1202FC WHB1207FC WHB1208FC	302023801 WHB1101FC 302023802 WHB1151FC 302023803 WHB1157FC 302023804 WHB1208FC	302023805 WHB1202FC 302023806 WHB1207FC 302023813 WHB1201FC	490062001 WHB1101FC WHB1151FC WHB1201FC 490062003 WHB1208FC WHB1202FC	490062004 WHB1157FC WHB1207FC
LIGHT		THERMAL FUSE	MANUAL LIMIT	THERMOSTAT	
					
3510-2017-007 WHB1101FC WHB1151FC WHB1201FC	3510-2017-006 WHB1157FC WHB1202FC WHB1207FC WHB1208FC	4520-2030-000 WHB1101FC WHB1151FC WHB1157FC WHB1201FC WHB1202FC WHB1207FC WHB1208FC	4520-11016-000 WHB1101FC WHB1151FC WHB1157FC WHB1201FC WHB1202FC WHB1207FC WHB1208FC	5813-2001-000 WHB1101FC WHB1151FC WHB1157FC WHB1202FC WHB1207FC WHB1208FC	5813-2022-000 WHB1201FC
DISCONNECT SWITCH	FAN BLADE	FAN DELAY	BACK BOX		
					
5216-2021-001 ALL MODELS	490061001 ALL MODELS	410074000 ALL MODELS	1217-2027-507 ALL MODELS		
PARTS KIT					
1205-11032-000 ALL MODELS					

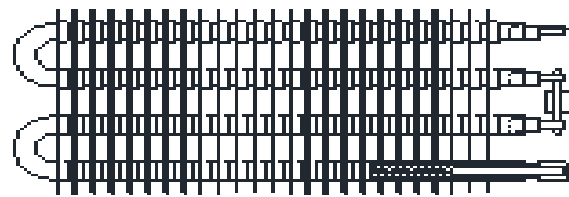
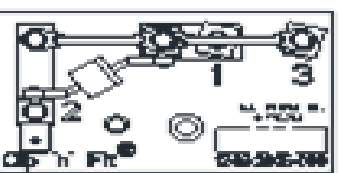
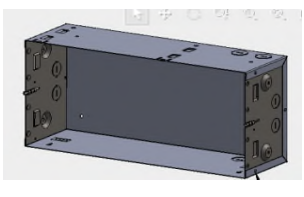
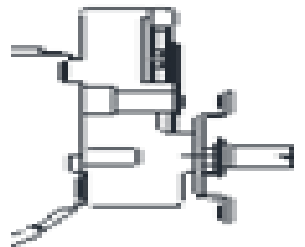
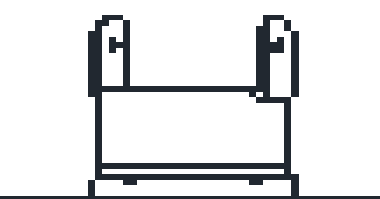
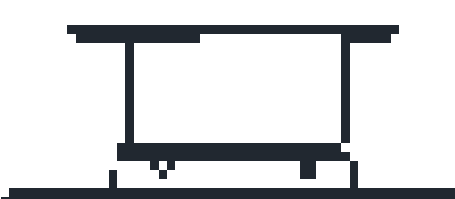
SRA ARCHITECTURAL SERIES (SWH)						
KNOB		GRILLE		ELEMENT		
						
3301-11015-003 SWH1012FC SWH1512FC SWH1527FC SWH1812FC SWH2020FC SWH2024FC SWH2027FC	3301-2052-002 SWH1012AG SWH1512AG SWH1527AG SWH1812AG SWH2020AG SWH2024AG SWH2027AG SWH1012AGA SWH1512AGA SWH1527AGA SWH1812AGA SWH2020AGA SWH2024AGA SWH2027AGA	1016-11227-000 SWH1012FC SWH1512FC SWH1527FC SWH1812FC SWH2020FC SWH2024FC SWH2027FC	2501-2075-000 SWH1012AG SWH1512AG SWH1527AG SWH1812AG SWH2020AG SWH2024AG SWH2027AG SWH1012AGA SWH1512AGA SWH1527AGA SWH1812AGA SWH2020AGA SWH2024AGA SWH2027AGA	302023801 SWH1012AG SWH1012AGA SWH1012FC 302023804 SWH2020AG SWH2020AGA SWH2020FC 302023813 SWH1812AG SWH1812AGA SWH1812FC	302023802 SWH1512AG SWH1512AGA SWH1512FC 302023805 SWH2024AG SWH2024AGA SWH2024FC	302023803 SWH1527AG SWH1527AGA SWH1527FC 302023806 SWH2027AG SWH2027AGA SWH2027FC
LIGHT				MOTOR		DISCONNECT SWITCH
						
3510-2008-002 SWH1527AG	3510-2008-003 SWH1012AG SWH1512AG SWH1812AG SWH2020AG SWH2024AG SWH2027AG	3510-2017-007 SWH1012AGA SWH1512AGA SWH1812AGA SWH1012FC SWH1512FC SWH1812FC	3510-2017-006 SWH1527AGA SWH2020AGA SWH2024AGA SWH2027AGA SWH1527FC SWH2020FC SWH2024FC SWH2027FC	490062001 SWH1012AG SWH1512AG SWH1812AG SWH1012AGA SWH1512AGA SWH1812AGA SWH1012FC SWH1512FC SWH1812FC 490062002 SWH2020AG SWH2020AGA SWH2020FC	490062003 SWH2024AG SWH2024AGA SWH2024FC 490062004 SWH1527AG SWH2027AG SWH1527AGA SWH2027AGA SWH1527FC SWH2027FC	5216-2021-001 ALL MODELS BACK BOX  1217-2027-507 ALL MODELS PARTS KIT 1205-11032-001 ALL MODELS
FAN DELAY	HI LIMIT	MANUAL LIMIT	FAN BLADE	THERMAL FUSE	THERMOSTAT	
						
410074000 ALL MODELS	410143000 SWH1012AG SWH1512AG SWH1527AG SWH1812AG SWH2020AG SWH2024AG SWH2027AG	4520-11016-000 SWH1012AGA SWH1512AGA SWH1527AGA SWH1812AGA SWH2020AGA SWH2024AGA SWH2027AGA SWH1012FC SWH1512FC SWH1527FC SWH1812FC SWH2020FC SWH2024FC SWH2027FC	490061001 ALL MODELS	4520-2030-000 SWH1012AGA SWH1512AGA SWH1527AGA SWH1812AGA SWH2020AGA SWH2024AGA SWH2027AGA SWH1012FC SWH1512FC SWH1527FC SWH1812FC SWH2020FC SWH2024FC SWH2027FC	5813-2022-000 SWH1812AG SWH1812AGA SWH1812FC	5813-2001-000 SWH1012AG SWH1512AG SWH1527AG SWH2020AG SWH2024AG SWH2027AG SWH1012AGA SWH1512AGA SWH1527AGA SWH2020AGA SWH2024AGA SWH2027AGA SWH1012FC SWH1512FC SWH1527FC SWH2020FC SWH2024FC SWH2027FC
						



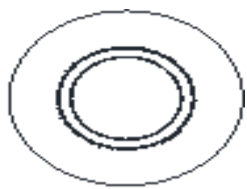
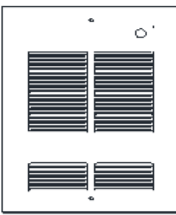

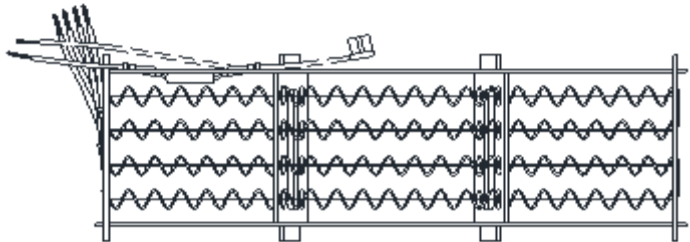
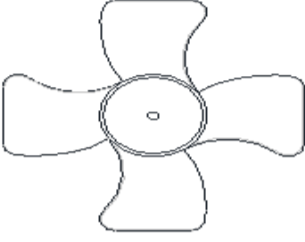
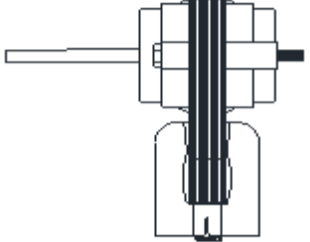
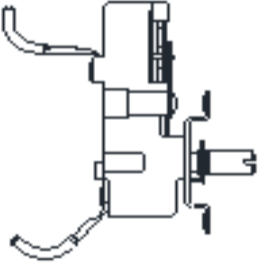
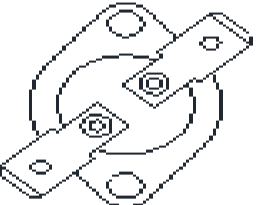
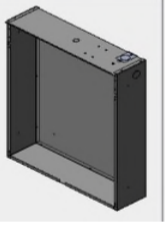
VFK-SERIES														
GRILLE		KNOB			FAN DELAY			MANUAL LIMIT						
														
2501-11028-000 K151FC K204FC K303FC K304FC K306FC K403FC K404FC K406FC K408FC K4083FC K483FC K484FC K486FC K487FC K488FC K4883FC		3301-2030-001 K151 K204A K204 K207A K207 K208A K208 K303A K303 K304A K304 K306A K306 K307A K307 K403A K403 K404A K404 K4043A K4043 K406A K406 K407A K408 K408A K4083 K4083A K483 K483A K484 K484A K4843 K4843A K486 K486A K487 K487A K488 K488A K4883 K4883A K157A			3301-11014-001 K151FC K204FC K303FC K304FC K306FC K403FC K404FC K406FC K408FC K4083FC K483FC K484FC K486FC K487FC K488FC K4883FC			4520-2024-000 K4043 K4043A K4083 K4083A K4083FC K4843 K4843A K488 K4883 K488A K4883A K488FC K4883FC			410074000 K204 K406FC K204A K408 K204FC K408A K208 K408FC K208A K483 K303 K483A K303A K483FC K303FC K484 K304 K484A K304A K484FC K304FC K486 K306 K486A K306A K486FC K306FC K207 K403 K207A K403A K307A K403FC K487 K404 K487A K404A K487A K404FC K487FC K406 K157A K406A K407A K151FC		4520-2027-000 ALL 1PH MODELS AUTO LIMIT  K4043 K4043A K4843 K4843A K4083 K4083A K4083FC K488 K4883 K488A K4883A K488FC K4883FC	
ELEMENTS				MOTOR				FAN BLADE						
														
302012827 K151 K151FC		302015802 K204 K204A K204FC		302015803 K207 K207A		302015801 K208 K208A		3900-2010-003 K151 K151FC						
302012819 K303 K303A K303FC		302012820 K306 K306A K306FC		302012809 K304 K304A K304FC		302012806 K307 K307A		3900-2010-000 K204 K404A K204A K404FC K208 K406 K208A K406A K303 K406FC K303A K408 K303FC K408A K304 K408FC K304A K483 K306 K483A K306A K483A K306FC K484 K403 K484A K403A K484A K403FC K486 K404 K486A K404 K486FC						
302012821 K403 K403A K403FC		1802-2075-802 K4043 K4043A		1802-2075-800 K4083 K4083A K4083FC		302012808 K404 K404A K404FC		3900-2010-001 K207 K207A K307 K307A K487 K487A K487FC K157A K407A						
302012822 K406 K406A K406FC		302012823 K483 K483A K483FC		302012810 K484 K484A K484FC		302012807 K408 K408A K408FC		3900-2002-518 K4043 K4043A K4083 K4083A K4083FC K4843 K4843A K488 K4883 K488A K4883A K488FC K4883FC						
302012824 K486 K486A K486FC		302012811 K487 K487A K487FC		1802-2075-801 K488 K488A K4883A K488FC K4883FC		1802-2075-803 K4843 K4843A		490030103 ALL MODELS BACK BOX  1016-11243-500 ALL MODELS PARTS KIT 1205-11031-002 ALL MODELS						
302015806 K157A														
THERMOSTAT				TRANSFORMER		RELAY		RELAY MODELS BEFORE 2020						
														
410168002 K4043 K4043A K4843 K4843A		5813-2027-000 K204 K404FC K204A K406 K204FC K406A K208 K406FC K208A K408 K303 K408A K303A K408FC K303FC K483 K304 K483A K304A K483FC K304FC K484 K306 K484A K306A K484FC K306FC K486 K403 K486A K403A K486FC K403FC K207 K404 K151FC K404A		490015017 K303 K403 K483 K303A K403A K483A K303FC K403FC K483FC		490015013 K306 K406 K486 K306A K406A K486A K306FC K406FC K486FC		410101002 K4043 K4083 K4043A K4083A K4843 K4083FC K4843A K488 K4843A K4883 K4843A K488A K4843A K4883A K4843A K488FC K4843A K4883FC		5018-2017-000 K4043 K4043A K4843 K4843A		5018-2017-004 K4083 K4083A K4083FC K488 K4883 K488A K4883A K488FC K4883FC		
						VFK-F 		VFK 						

GFR SERIES								
KNOB		GRILLE			LIGHT			
								
3301-2014-004 R1500T2 R2004T2 R2404T2 R1500T2A R2004T2A R2404T2A R1500T2B R2004T2B R2404T2B	3301-11015-002 R1500T2FC R2004T2FC R2404T2FC	2501-11031-000 R1500FC R1500T2FC R2004FC R2004IFFC R2004T2FC R2404FC R2404IFFC R2404T2FC R1500A R1500T2A R2004A R2004IFA			3510-2010-000 R1500 R1500T2 R1500A R1500T2A R1500B R1500T2B R1500FC R1500T2FC	3510-2010-001 R2004 R2004IF R2004T2 R2004A R2004IFA R2004T2A R2004B R2004IFB R2004T2B R2004FC R2004IFFC R2004T2FC		R2404 R2404IF R2404T2 R2404A R2404IFA R2404T2A R2404B R2404IFB R2404T2B R2404FC R2404IFFC R2404T2FC
BLOWER ASM.				ELEMENT		CLIP N FIT BOARD		
								
1225-2002-000 R1500 R1500T2 R1500A R1500T2A R1500B R1500T2B R1500FC R1500T2FC	R2404A R2404IFA R2404T2A R2404B R2404IFB R2404T2B R2404FC R2404IFFC R2404T2FC	1225-2002-001 R2004 R2004IF R2004T2 R2404 R2404IF R2404T2 R2004A R2004IFA R2004T2A	R2004B R2004IFB R2004T2B R2004FC R2004IFFC R2004T2FC	302023802 R1500 R1500T2 R1500A R1500T2A R1500B R1500T2B R1500FC R1500T2FC	302023805 R2004 R2004IF R2004T2 R2004A R2004IFA R2004T2A R2004B R2004IFB R2004T2B R2004FC R2004IFFC R2004T2FC	302023814 R2404 R2404IF R2404T2 R2404A R2404IFA R2404T2A R2404B R2404IFB R2404T2B R2404FC R2404IFFC R2404T2FC	1249-2005-000 ALL MODELS BACK BOX  1217-2044-000 ALL MODELS PARTS KIT 1205-11033-000 ALL MODELS	
THERMOSTAT	TEMPERATURE REGULATOR			HI-LIMIT				
								
410130001 R1500T2 R2004T2 R2404T2 R1500T2A R2004T2A R2404T2A R1500T2B R2004T2B R2404T2B R1500T2FC R2004T2FC R2404T2FC	410143000 R1500 R1500T2 R2004 R2004IF R2004T2 R1500A R1500T2A R2004A R2004IFA R2004T2A		4520-2029-000 R2404 R2404IF R2404T2 R2404A R2404IFA R2404T2A R2404B R2404IFB R2404T2B R2404FC R2404IFFC R2404T2FC	4520-2025-000 R1500 R1500T2 R2004 R2004IF R2004T2 R1500A R1500T2A R2004A R2004IFA R2004T2A	4520-2025-001 R2404 R2404IF R2404T2 R2404A R2404IFA R2404T2A	4520-11010-000 R1500B R1500T2B R1500FC R1500T2FC	4520-11010-001 R2004B R2004IFB R2004T2B R2004FC R2004IFFC R2004T2FC R2404B R2404IFB R2404T2B R2404FC R2404IFFC R2404T2FC	
								

SED SERIES					
KNOB		GRILLE		LIGHT	
					
3301-2044-001 D1012C D1024C D1012CA D1024CA	3301-2039-002 D1012W D1512 D2024 D1012WA D1024WA D1512A D2024A	2501-2054-001 D1012C D1024C D1512CR D1012CA D1024CA D1512CRA	2501-2054-000 D1012W D1512 D2024 D1012WA D1024WA D1512A D2024A	3510-2017-002 D1012C D1012W D1512 D1512CR D1012CA D1012WA D1512A D1512CRA	3510-2017-003 D1024C D2024 D1024CA D1024WA D2024A
ELEMENT			FAN BLADE	MOTOR	
					
1802-2124-003 D1012C D1012W D1012CA D1012WA	1802-2124-005 D1024C D2024 D1024CA D1024WA D2024A	1802-2124-000 D1512 D1512CR D1512A D1512CRA	1210-2008-000 ALL MODELS	3900-2037-000 D1012C D1012W D1512 D1512CR D1012CA D1012WA D1512A D1512CRA	3900-2037-001 D1024C D2024 D1024CA D1024WA D2024A
THERMOSTAT		LIMIT			BACK BOX
					
410130001 D1012C D1012W D1512 D1012CA D1012WA D1512A D1024C D2024		4520-11009-000 D1012C D1012W D1512 D1512CR D1024C D2024		4520-11009-001 D1024CA D1024WA D2024A	1217-2062-000 ALL MODELS PARTS KIT 1205-2049-501 ALL MODELS

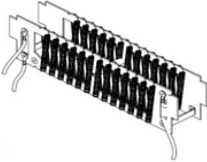
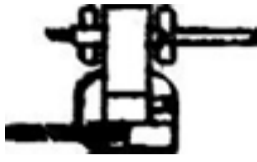

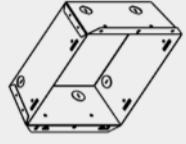
COZ-E WALL HEATER

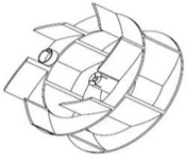
ELEMENT (INCLUDES LIMIT & ONE SHOT FUSE)		MOTOR		GRILLE
				
1802-11014-011 CZ1012TB	1802-11014-010 CZ1512TB	3900-11032-000 CZ1012IF CZ1012T CZ1512IF CZ1512T	3900-11032-001 CZ1048IF CZ1048T CZ1548IF CZ1548T CZ2048IF CZ2048T	2501-11024-000 ALL MODELS
				BACK BOX
				
				1217-11030-000 ALL MODELS
THERMOSTAT	FAN IMPELLER	PARTS KIT		
		PICTURE NOT AVAILABLE		
5813-2090-000 CZ1012T CZ1048T CZ1512T CZ1548T CZ2048T	2002-11004-000 ALL MODELS	1205-11028-500 CZ1012T CZ1048T CZ1512T CZ1548T CZ2048T		









QTS SERIES							
ELEMENTS		MOTOR ASSEMBLY		HI-LIMIT	SELF HOLD LIMIT	FAN DELAY	
302023811 S1100 S1100A S1100B S1100C S1100CNW	302023803 S1104 S1104A S1104B S1104C S1104CNW	1225-2002-000 S1100 S1100A S1100B S1100C S1100CNW	1225-2002-001 S1104 S1104A S1104B S1104C S1104CNW	4520-2031-000 S1100 S1100A S1100B S1104 S1104A S1104B S1500 S1500A S1500B S1500C S1500T S1500TA S1500TB S1500TC S1500TCNW	4520-11011-000 S1100C S1100CNW S1500C S1500TC S1500TCNW	1414-2020-000 S1100 S1100A S1104 S1104A S1500 S1500A S1500T S1500TA S1504 S1504A S1504TA	410074000 S1100B S1100C S1100CNW S1104B S1104C S1104CNW S1500B S1500C S1500TC S1500TCNW S1504B S1504C S1504TB S1504TC S1504TCNW
302023802 S1500 S1500A S1500B S1500C S1500T S1500TA S1500TB S1500TC S1500TCNW	302023806 S1504 S1504A S1504B S1504C S1504T S1504TA S1504TB S1504TC S1504TCNW	S1500 S1500A S1500B S1500C S1500T S1500TA S1500TB S1500TC S1500TCNW	S1504 S1504A S1504B S1504C S1504T S1504TA S1504TB S1504TC S1504TCNW	S1504B S1504C S1504T S1504TA S1504TB S1504TC S1504A S1504B S1504T S1504TA S1504TB	4520-11011-001 S1104C S1104CNW S1504C S1504TC S1504TCNW	S1500A S1500T S1500TA S1504 S1504A S1504TA	S1500B S1500C S1500TC S1500TCNW S1504B S1504C S1504TB S1504TC S1504TCNW
PILOT LIGHT		GRILLE		THERMOSTAT	KNOB	THERMAL CUTOFF	
3510-2010-000 S1100A S1100B S1100C S1100CNW S1500A S1500B S1500C S1500TA S1500TB S1500TC S1500TCNW	3510-2010-001 S1104 S1104A S1104B S1104C S1104CNW S1504 S1504A S1504B S1504C S1504T S1504TA S1504TB S1504TC S1504TCNW	2501-2039-000 S1100 S1100A S1100B S1100C S1104 S1104A S1104B S1104C S1500 S1500A S1500B S1500C S1500T S1500TA S1500TB		2501-2039-001 S1100CNW S1504 S1104CNW S1500CNW S1504TCNW	410129001 S1500T S1500TA S1500TB S1500TC S1500TCNW S1504T S1504TA S1504TB S1504TC S1504TCNW	3301-2020-006 S1500T S1500TA S1500TB S1500TC S1500TCNW S1504T S1504TA S1504TB S1504TC S1504TCNW	4520-2030-000 ALL MODELS

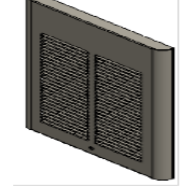

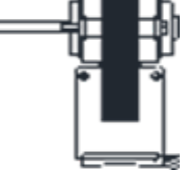





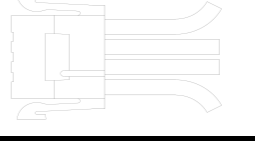



FDI SERIES				
BLADE	ELEMENT	GRILLE	BUZZER	
1210-0046-000 I1500 I1504	1802-5032-000 I1500	1802-5032-004 I1504	2501-5016-001 I1500 I1504	2714-2001-001 I1500 I1504
MOTOR		ONE SHOT FUSE BLUE DOT	HI LIMIT WHITE DOT	
3900-2025-000 I1500	3900-2025-001 I1504	4520-2041-000 I1500 I1504	4520-5015-001 I1500 I1504	

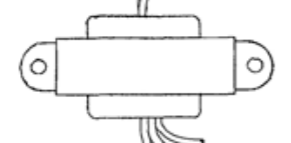

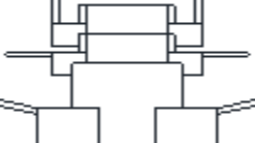

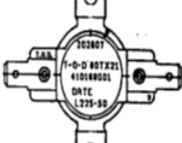

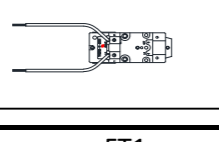

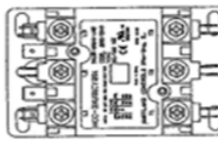

HT SERIES PUMP HOUSE HEATER			
ELEMENT	KNOB	THERMOSTAT	 * Neutral grey finish.
1802-2091-000	3301-2020-006	5813-2062-000	

CFWF (OBSOLETE)					
TOP FRONT PANEL	BOTTOM FRONT PANEL	TOP TRIM PANEL	MOTOR	RELAY	TRANSFORMER
1402-2312-000 CFWF920 CFWF920A	1402-2313-000 CFWF920 CFWF920A	5806-2004-000 CFWF920 CFWF920A	3900-2036-000 CFWF920 CFWF920A	5018-2017-001 CFWF920 CFWF920A	5814-0003-000 CFWF920 CFWF920A
HI-LIMIT	MANUAL RESET LIMIT	ELEMENT	FAN BLADE	PILOT LIGHT	CERAMIC LIMITS
4520-2053-000 CFWF920	4520-2027-000 CFWF920A	1802-2117-101 CFWF920 CFWF920A	1210-2009-001 CFWF920 CFWF920A	3510-2018-000 CFWF920 CFWF920A	4520-2052-000 CFWF920 CFWF920A

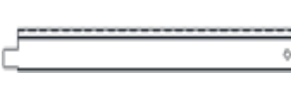

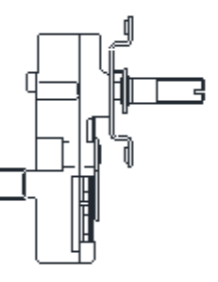
QCH (U SERIES)						
GRILLE		PLASTIC COVER (2 REQ)	ELEMENTS		MOTOR	
						
1402-2121-000 U1000 U1000A U1500 U1500A U1507 U1800 U2004 U2004A U2007 U2007A U2008	1016-11228-002 U1000FA U1500FA U2004FA U2007FA	1402-2119-000 U1000 U1000A U1500 U1500A U1507 U1800 U2004 U2004A U2007 U2007A U2008	302023812 U1000 U1000A U1000FA 302023802 U1500 U1500A U1500FA 302023805 U2004 U2004A U2004FA	302023803 U1507 302023808 U1800 302023806 U2007 U2007A U2007FA 302023804 U2008	490062001 U1000 U1000A U1000FA U1500 U1500A U1500FA U1800 490062004 U1507	490062003 U2004 U2004A U2004FA 490062004 U2007 U2007A U2007FA 490062002 U2008
LIGHT		FAND DELAY	HI-LIMIT	FAND BLADE	DISCONNECT SW	SOCKET ASSEMBLY
						
3510-2008-003 U1000A U1000FA U1500A U1500FA	3510-2008-002 U2004A U2004FA U2007A U2007FA	410074000 ALL MODELS	410143000 ALL MODELS	490061001 ALL MODELS	410170001 ALL MODELS	480108903 ALL MODELS

QFF (F SERIES)						
MOTOR		ELEMENT			DISCONNECT	
						
3900-2002-520 F1500	3900-2002-500 F2004	302012827 F1500	302012821 F4003	302012811 F4807	410170001 F1500	5216-2019-000 F3003
3900-2002-501 F1507 F2007 F3007 F4007 F4807	F2008 F3003 F3006 F4003 F4004 F4006 F4008	302015806 F1507 302015802 F2004 302015803 F2007	302012808 F4004 302012822 F4006 302012809 F4007	1802-2075-802 F40043 1802-2075-800 F40083 1802-2075-803 F48043	F1507 F2004 F2007 F2008 F3007 F4004 F4007 F4008 F4804 F4807	F3006 F4003 F40043 F4006 F40083 F4803 F48043 F4806 F4808 F48083 F48483 F48483LV
3900-2002-518 F40043 F40083 F48043 F4808 F48083	F4804 F4806 3900-2010-000 F48483 F48483LV	302015801 F2008 302012819 F3003 302012820 F3006 302012806 F3007	302012807 F4008 302012823 F4803 302012810 F4804 302012824 F4806	1802-2075-801 F4808 F48083 1802-2075-804 F48483 F48483LV	F4804 F4807	F48043 F4806 F4808 F48083 F48483 F48483LV
POWER TR.	SECONDARY TR.	RELAY MODELS BEFORE 2020	RELAY	AUTO LIMIT	HI-LIMIT	FAN DELAY
						
490015017 F3003 F4003 F4803	490065002 F48483LV UNIT MOUNTED T' STAT  FT1	5018-2017-000 F40043 F48043 F48483 5018-2017-004 F40083 F4808 F48083 5018-2017-001 F48483LV	410101002 F40043 F48043 F48483 F4808 F48083 410101001 F48483LV	4520-2048-000 F40043 F48043 F48483 F4808 F48083	410169001 ALL MODELS GRILLE 	410074000 ALL MODELS FAN BLADE 
490015013 F3006 F4006 F4806					1402-2139-001 ALL MODELS	490030103 ALL MODELS
490015022 F48483 F48483LV						

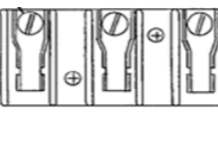
FFCH (500 SERIES)					
ELEMENT	MOTOR	RELAY	OUTLET GRILLE (2 REQ'D)	LOUVER GUIDES NAV W.	LOUVER GUIDES NOR W.
					
302012802 542	302012813 552	3900-2011-000 542	2501-2020-001 NAVAJO WHITE	1215-2059-000 REA (2 REQ'D)	1215-2059-002 REA (2 REQ'D)
302012803 547	302012814 557	548	2501-2020-002 NORTHERN WHITE	1215-2059-001 SEA (2 REQ'D)	1215-2059-003 SEA (2 REQ'D)
302012801 548	302012812 558	552	GRILLE PANEL 	GRILLE PANEL 	THERMOSTAT 
3900-2011-001 547 557		5018-11006-001 547 557	NAVAJO SEB 2701-11005-000 NORTHERN SEBNW 2701-11005-001	NAVAJO REB 4513-11057-001 NORTHERN REBNW 4513-11057-000	500T ALL MODELS
FAN DELAY	FAN BLADE	HI-LIMIT	POWER BLOCK		
					
1414-2039-000 ALL MODELS	1210-2000-000 ALL MODELS	4520-0011-000 ALL MODELS	5823-0004-000 MODELS NOT ENDING IN A		

* MODELS ENDING IN (A) USE SAME PARTS BUT DO NOT HAVE POWER BLOCKS

CUH900 SERIES

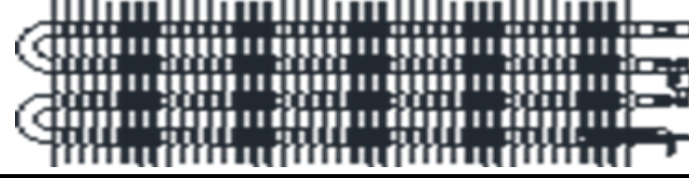

ELEMENTS

MODEL	NO. REQ	208V	NO. REQ	240V	NO. REQ	277V	NO. REQ	347V	NO. REQ	380V	NO. REQ	480V	NO. REQ	600V
935														
2KW	1	1802-2083-100	1	1802-2083-101	1	1802-2083-114	1	1802-2083-103	1	1802-2083-101	1	1802-2083-114	1	1802-2083-103
3KW	1	1802-2083-107	1	1802-2083-108	1	1802-2083-116	1	1802-2083-105	1	1802-2083-108	1	1802-2083-116	1	1802-2083-105
4KW	1	1802-2083-106	1	1802-2083-107	1	1802-2083-108	1	1802-2083-109	1	1802-2083-107	1	1802-2083-118	1	1802-2083-109
5KW	1	1802-2083-110	1	1802-2083-111	1	1802-2083-120	1	1802-2083-113	1	1802-2083-111	1	1802-2083-120	1	1802-2083-113
6KW	2	1802-2083-107	2	1802-2083-108	2	1802-2083-116	2	1802-2083-105	2	1802-2083-108	2	1802-2083-116	2	1802-2083-113
7KW	1	1802-2083-106	1	1802-2083-107	1	1802-2083-116	1	1802-2083-105	1	1802-2083-107	1	1802-2083-116	1	1802-2083-105
	1	1802-2083-107	1	1802-2083-108	1	1802-2083-118	1	1802-2083-109	1	1802-2083-108	1	1802-2083-118	1	1802-2083-109
8KW	1	1802-2083-107	1	1802-2083-108	1	1802-2083-116	1	1802-2083-105	1	1802-2083-108	1	1802-2083-116	1	1802-2083-105
	1	1802-2083-110	1	1802-2083-111	1	1802-2083-120	1	1802-2083-113	1	1802-2083-111	1	1802-2083-120	1	1802-2083-113
MODEL	NO. REQ	208V	NO. REQ	240V	NO. REQ	277V	NO. REQ	347V	NO. REQ	380V	NO. REQ	480V	NO. REQ	600V
945														
4KW	2	1802-2083-100	2	1802-2083-101	2	1802-2083-114	2	1802-2083-103	2	1802-2083-101	2	1802-2083-114	2	1802-2083-103
6KW	2	1802-2083-107	2	1802-2083-108	2	1802-2083-116	2	1802-2083-105	2	1802-2083-108	2	1802-2083-116	2	1802-2083-105
8KW	2	1802-2083-106	2	1802-2083-107	2	1802-2083-108	2	1802-2083-109	2	1802-2083-107	2	1802-2083-118	2	1802-2083-109
10KW	2	1802-2083-110	2	1802-2083-111	2	1802-2083-120	2	1802-2083-113	2	1802-2083-111	2	1802-2083-120	2	1802-2083-113
12KW	4	1802-2083-107	4	1802-2083-108	4	1802-2083-116	4	1802-2083-105	4	1802-2083-108	4	1802-2083-116	4	1802-2083-113
14KW	2	1802-2083-106	2	1802-2083-107	2	1802-2083-116	2	1802-2083-105	2	1802-2083-107	2	1802-2083-116	2	1802-2083-105
	2	1802-2083-107	2	1802-2083-108	2	1802-2083-118	2	1802-2083-109	2	1802-2083-108	2	1802-2083-118	2	1802-2083-109
16KW	2	1802-2083-107	2	1802-2083-108	2	1802-2083-116	2	1802-2083-105	2	1802-2083-108	2	1802-2083-116	2	1802-2083-105
	2	1802-2083-110	2	1802-2083-111	2	1802-2083-120	2	1802-2083-113	2	1802-2083-111	2	1802-2083-120	2	1802-2083-113

58" AND LARGER HEATERS CONTACT FACTORY WITH CFID# ON UNIT'S NAMEPLATE

LOUVERED PANELS











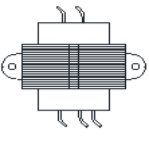
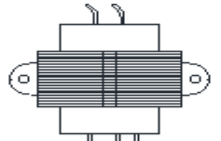
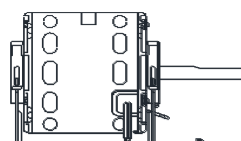
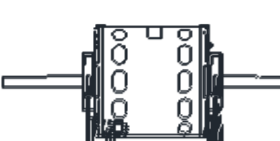

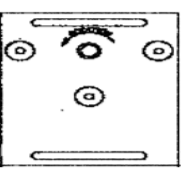
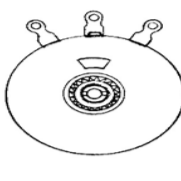

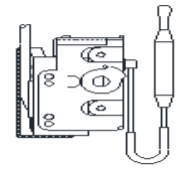
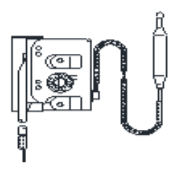
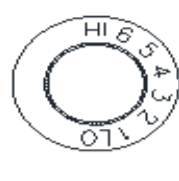
DESERT TAN	35"	4513-2114-T35	NAVAJO WHITE	35"	4513-2114-P35	NORTHERN WHITE	35"	4513-2114-W35	STAT BRONZE	35"	4513-2114-S35
	45"	4513-2114-T45		45"	4513-2114-P45		45"	4513-2114-W45		45"	4513-2114-S45
	58"	4513-2114-T58		58"	4513-2114-P58		58"	4513-2114-W58		58"	4513-2114-S58
	78"	4513-2114-T78		78"	4513-2114-P78		78"	4513-2114-W78		78"	4513-2114-S78
ALUMINUM	35"	4513-2114-A35	BLACK	35"	4513-2114-B35	CHARCOL GREY	35"	4513-2114-G35	NEUTRAL GREY	35"	4513-2114-N35
	45"	4513-2114-A45		45"	4513-2114-B45		45"	4513-2114-G45		45"	4513-2114-N45
	58"	4513-2114-A58		58"	4513-2114-B58		58"	4513-2114-G58		58"	4513-2114-N58
	78"	4513-2114-A78		78"	4513-2114-B78		78"	4513-2114-G78		78"	4513-2114-N78



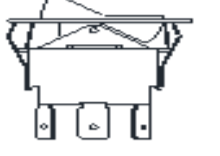
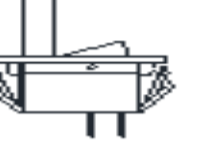
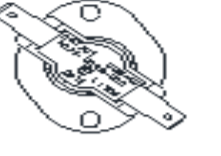
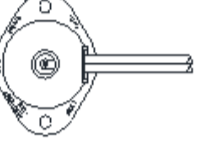

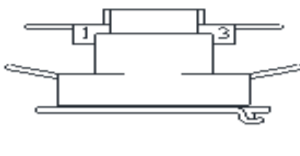
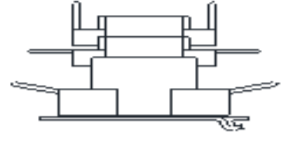
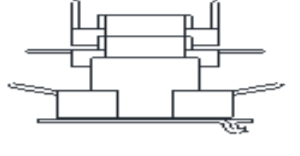
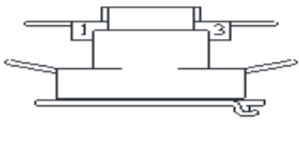
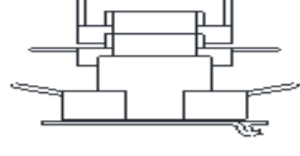

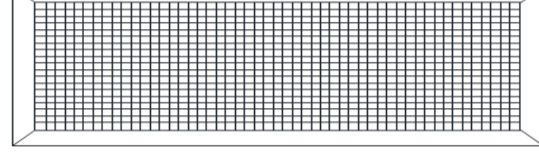
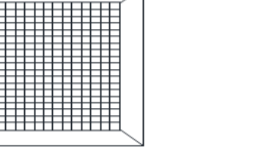
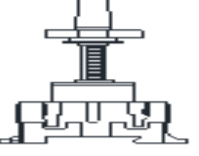
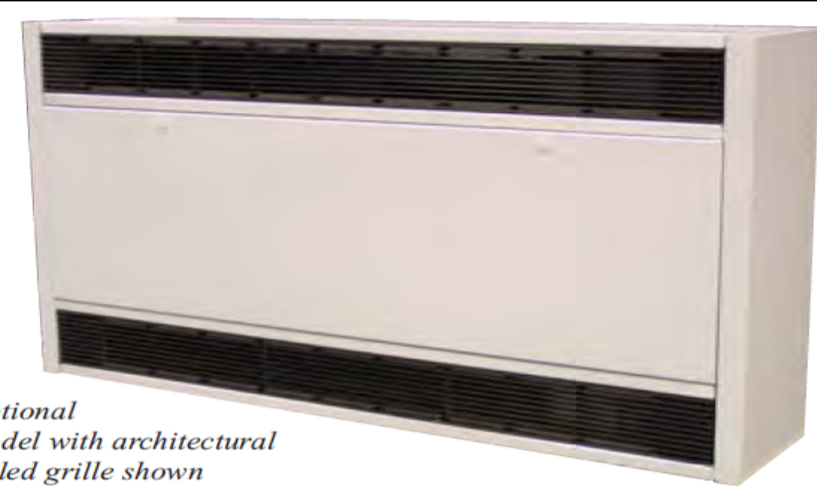

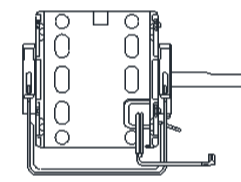
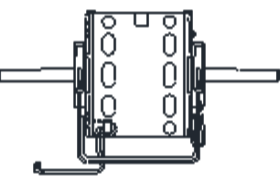
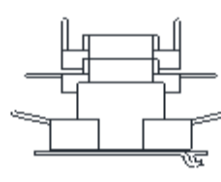
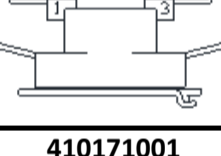
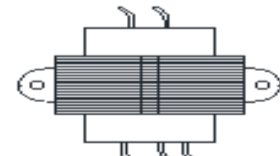

PANEL GRILLES NEW MODELS

NORTHERN WHITE	35"	2501-11040-000W	BEIGE	35"	2501-11040-000N	BLACK	35"	2501-11040-000B	ALUMINUM	35"	2501-11040-000A
	45"	2501-11040-001W		45"	2501-11040-001N		45"	2501-11040-001B		45"	2501-11040-001A
	68"	2501-11040-003W		68"	2501-11040-003N		68"	2501-11040-003B		68"	2501-11040-003A
	78"	2501-11040-004W		78"	2501-11040-004N		78"	2501-11040-004B		78"	2501-11040-004A
STAT BRONZE	35"	2501-11040-000S									
	45"	2501-11040-001S									
	68"	2501-11040-003S									
	78"	2501-11040-004S									

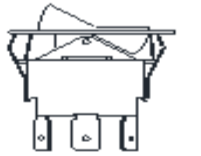
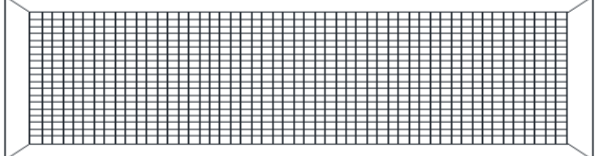
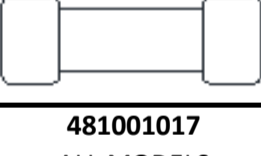
LOUVERED PANELS 2020 AND NEWER MODELS

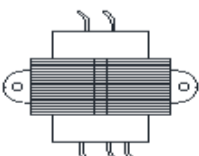
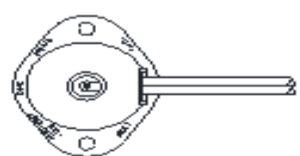
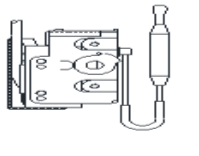

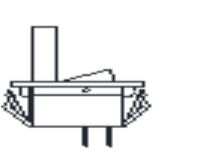

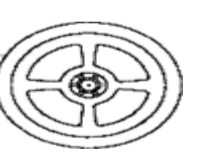
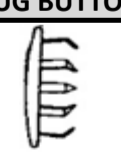

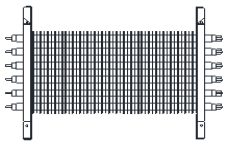
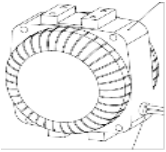

NORTHERN WHITE	35"	2501-11044-000W	BEIGE	35"	2501-11044-000N	BLACK	35"	2501-11044-000B	ALUMINUM	35"	2501-11044-000A
	45"	2501-11044-001W		45"	2501-11044-001N		45"	2501-11044-001B		45"	2501-11044-001A
	68"	2501-11044-003W		68"	2501-11044-003N		68"	2501-11044-003B		68"	2501-11044-003A
	78"	2501-11044-004W		78"	2501-11044-004N		78"	2501-11044-004B		78"	2501-11044-004A
STAT BRONZE	35"	2501-11044-000S									
	45"	2501-11044-001S									
	68"	2501-11044-003S									
	78"	2501-11044-004S									

CUH900 CONTINUED						
PRIMARY TRANSFORMER		SEC. TRANSFORMER		MOTORS		BLOWER WHEEL
						
CONTACT FACTORY WITH CFID# ON UNIT'S NAMEPLATE OR TRANSFORMER LABEL, PART NUMBERS ARE GENERALLY ON THE PART'S LABEL		490026910 MODELS WITH 24V CONTR.		SINGLE SHAFT DOUBLE SHAFT MOTOR PART NUMBERS ARE ON THE MOTOR NAMEPLATE LABEL. CONTACT FACTORY IF MOTOR LABEL IS NOT AVAILABLE.		490047001 ALL MODELS
DAMPER MOTOR	DAMPER RHEOSTAT	DAMPER RHEOSTAT KNOB	THERMOSTAT SPST	THERMOSTAT 2STG	THERMOSTAT KNOB	PLUG BUTTON
						
3900-2023-000 MODELS WITH AIR DAMPER	410104001 MODELS WITH AIR DAMPER	482084001 MODELS WITH AIR DAMPER	410127001 SINGLE STAGE MODELS	5813-2008-000 TWO STAGE MODELS	3301-2020-001 ALL MODELS	4506-2012-000 ALL MODELS
DAMPER ROCKER SW	FAN AUTO/ON SW	ON/OFF SW	HIGH/LOW SW	DOOR SAFETY SW	AUTO HIGH LIMIT	MANUAL LIMIT
						
410131001 MODELS WITH AIR DAMPER	5216-2029-001 ALL MODELS	5216-2029-001 ALL MODELS	5216-2029-000 SINGLE STAGE MODELS	5216-2028-000 ALL MODELS	4520-2048-000 ALL MODELS	4520-2017-000 ALL MODELS
FAN AUTO RELAY (120V)	FAN DELAY RELAY(120V)	POWER RELAY (120)	FAN AUTO RELAY (24V)	FAN DELAY RELAY (24V)	POWER RELAY (24)	NIGHT SETBACK RELAY
						
410101003 MODELS WITH 120V CONTROL	410171002 MODELS WITH 120V CONTROL	410101003 MODELS WITH 120V CONTROL	410101001 MODELS WITH 24V CONTROL	410171001 MODELS WITH 24V CONTROL	410101001 MODELS WITH 24V CONTROL	410101001 MODELS WITH N.S. RELAY
FUSE	FILTER	FILTER REUSABLE	DISCONNECT SW		NOTES:	
					* TAKES TWO MOTORS ** TAKES ONE OF EACH TYPE MOTOR	
481001017 ALL MODELS	2010-7008-006 CU935	2010-7009-006 CU935	30 AMP 60 AMP 100 AMP		5216-2033-000 5216-2033-001 5216-2033-002	
FUSE HOLDER	2010-7008-007 CU945	2010-7009-007 CU945				
	2010-7008-008 CU958	2010-7009-008 CU958				
480087001 ALL MODELS	2010-7008-009 CU968	2010-7009-009 CU968				
	2010-7008-010 CU978	2010-7009-010 CU978				

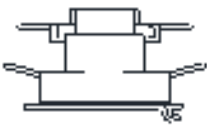



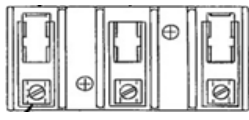



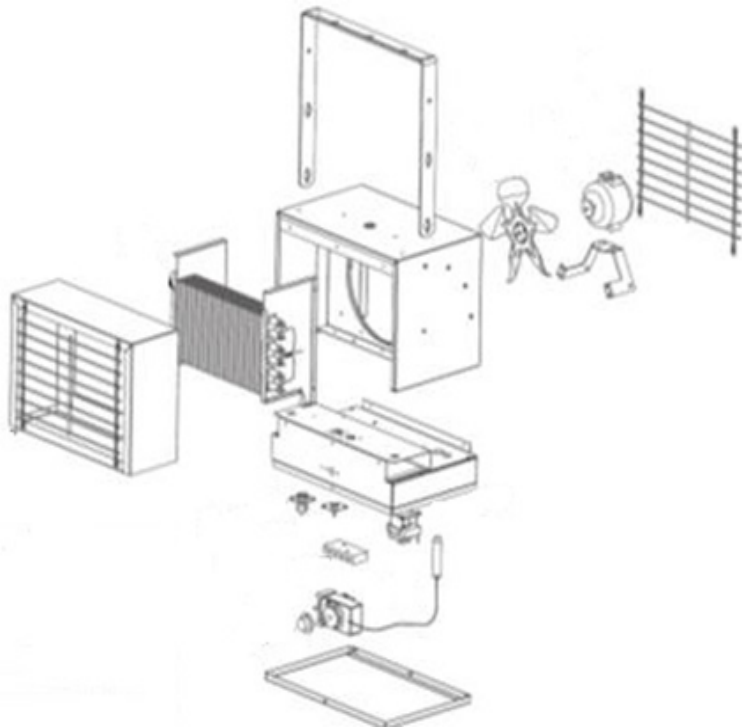

CUH 900 SERIES STOCK MODELS						
ELEMENT		CAPACITOR		MOTOR		TIME DELAY RELAY
						
1802-2083-110 S93505203FFB S94510203FFB		1432-0002-003 S93505203FFB S93505243FFB S93505483FFB S93505603FFB S94510243FFB S94510483FFB S94510603FFB		SINGLE SHAFT DOUBLE SHAFT MOTOR PART NUMBERS ARE ON THE MOTOR NAMEPLATE LABEL. CONTACT FACTORY IF MOTOR LABEL IS NOT AVAILABLE.		410101001 ALL MODELS
1802-2083-111 S93505243FFB S94510243FFB		1432-0002-001 S94510203FFB				FAN DELAY RELAY 
1802-2083-121 S93505603FFB S94510603FFB						410171001 ALL MODELS
PRI. TRANSFORMER	LIMIT	HIGH/LOW SW.	FILTER		FUSE	
						
490015025 S93505483FFB S94510483FFB	490015026 S93505603FFB S94510603FFB	4520-2048-000 ALL MODELS	2010-7008-006 S93505203FFB S93505243FFB S93505483FFB S93505603FFB		481001017 ALL MODELS	
490026002 S93505271FFNC S94510271FFNC	5814-0003-002 S93505483FFNC S94510483FFNC	5216-2029-000 ALL MODELS	2010-7008-007 S94510203FFB S94510243FFB S94510483FFB S94510603FFB		FUSE HOLDER 	
SEC. TR (240/24V)	MANUAL RESET	THERMOSTAT	T'STAT KNOB	DOOR SW.	FAN AUTO/ON SW.	BLOWER WHEEL
						
490026910 ALL MODELS	4520-2017-000 ALL MODELS	410127001 ALL MODELS	3301-2020-001 ALL MODELS	5216-2028-000 ALL MODELS	5216-2029-001 ALL MODELS	490047001 ALL MODELS
						PLUG BUTTON
						
						4506-2012-000 ALL MODELS

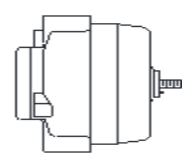
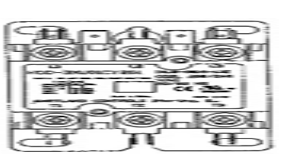
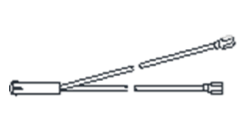
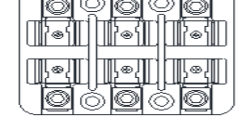
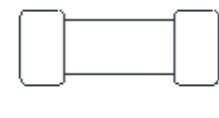

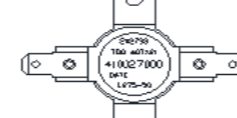
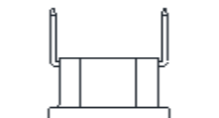
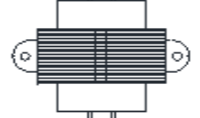



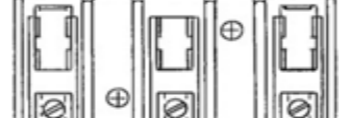





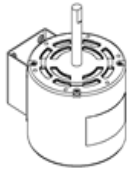
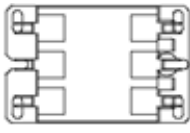
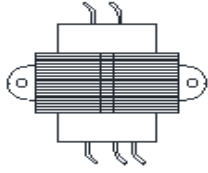

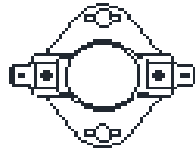
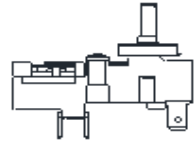
COMPACT FREEZE PROTECTION HEATERS PHFP25

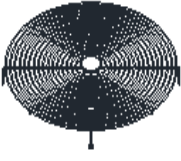
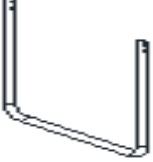
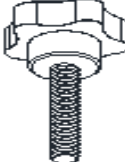
ELEMENT	MOTOR	FAN BLADE	FAN RELAY	RELAY
				
1802-11002-000 PHFP25	3900-11007-001 PHFP25	1210-2017-000 PHFP25	410171003 PHFP25	1414-2038-000 PHFP25
THERMOSTAT	KNOB	HI LIMIT	POWER BLOCK	MT. BRACKET
				
5813-2091-000 PHFP25	3301-2053-000 PHFP25	1414-2037-000 PHFP25	5823-0004-005 PHFP25	310876001 PHFP25

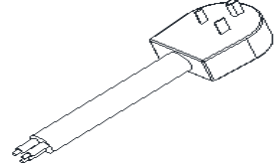

HUH SERIES									
ELEMENT			FAN BLADE		MOTOR		CONTACTOR		
									
302006804 UH520 UH520A	302006811 UH727 UH727A	302006842 UH1534 UH1560	1210-2017-000 UH520 UH520A	490011001 UH1020 UH1024	3900-2008-000 UH520 UH520A	490059004 UH1020 UH1024	5018-0004-102 UH520A UH524A	5018-0003-002 UH534 UH534A	5018-0005-006 UH1020 UH1024
302006807 UH524 UH524A	302006840 UH734 UH734A	302006829 UH2548	UH524 UH524A	UH1027 UH1034	UH524 UH524A	UH1027 UH1034	UH538 UH538A	UH734 UH734A	UH1027 UH1048
UH548 UH548A	UH760 UH760A	302006843 UH2560	UH534 UH534A	UH1048 UH1060	UH534 UH534A	UH1048 UH1060	UH548 UH548A	UH1534	UH1060 UH1520
302006839 UH534 UH534A	302006812 UH1020 UH1527	302006822 UH3048	UH538A UH548 UH548A	UH1520 UH1524	UH538 UH538A	UH1520 UH1524	UH560 UH560A	5018-0004-103 UH727 UH727A	UH1524 UH1527
UH560 UH560A	302006813 UH1024	302006844 UH3060	UH560 UH560A	UH1527 UH1534	UH548 UH548A	UH1527 UH1534	UH720 UH724		UH1548 UH1560
302006848 UH538 UH538A	UH1048 UH1520 UH2048		UH720 UH720A	490011002 UH2034 UH2048	UH720 UH720A	UH2034 UH2048	UH748 UH748A		UH2034 UH2048
302006809 UH720 UH720A	302006814 UH1027 UH1524		UH724 UH727	490013001 UH2548 UH2560	UH724 UH724A	UH2060 UH748 UH748A	490059006 UH2548 UH2560		UH2548 UH2560
302006810 UH724 UH724A	302006841 UH1034 UH1060		UH734 UH748 UH748A	490013002 UH3048 UH3060	UH727 UH727A	3900-2008-001 UH727 UH727A	UH3048 UH3060		UH3048 UH3060
UH748 UH748A	UH2034 UH2060		UH760 UH760A						
LIGHT	FUSE BLOCK	FUSE	CAPACITOR	HI LIMIT	FAN DELAY	TRANSFORMER			
									
3510-2017-003 UH524A UH724A	480099002 UH1020 UH1024 UH1520	481001003 UH1020 UH1024 UH1520	1432-0002-003 UH2548 UH2560 UH3048 UH3060	410027000 ALL MODELS	410148000 ALL MODELS	490015017 UH534 UH534A UH734 UH734A	490015013 UH560 UH560A UH760 UH760A	490015010 UH1048 UH1548 UH2048	
	480099003 UH1520 UH1524	UH1534 UH2034				490015014 UH538 UH538A	490015009 UH1027 UH1527	490015012 UH1060 UH1560 UH2060	
	480096000 UH1527	481001006 UH1520 UH1524				490056001 UH548 UH548A UH748 UH748A	490015019 UH1034 UH1534 UH2034	490015008 UH2548 UH3048	
	480099001 UH1534 UH2034	481001023 UH1527						490015015 UH2560 UH3060	
	2025-0001-000 UH2034	2019-7002-007 UH2034							
QUANTITY	LOUVER	LOUVER SPRING	HOLE PLUG	MT. BRACKET	POWER BLOCK	THERMOSTAT (ASSM INCLUDES KNOB)			
5 & 7.5KW (4) 10 THRU 20KW (6) 25 & 30KW (9)									
3503-2004-109 UH520 UH520A UH524 UH524A UH534 UH534A UH538 UH538A UH548 UH548A UH560 UH560A UH720 UH720A UH724 UH724A UH727 UH727A UH734 UH734A UH748 UH748A UH760 UH760A	3503-2004-111 UH1020 UH1024 UH1027 UH1034 UH1048 UH1060 UH1520 UH1524 UH1527 UH1534 UH1548 UH1560 UH2034 UH2048 UH2060	3503-2004-112 UH2548 UH2560 UH3048 UH3060	5208-7005-001 ALL MODELS	29214-11621 UH520 UH520A UH524 UH524A UH534 UH534A UH538 UH538A UH548 UH548A UH560 UH560A UH720 UH720A UH724 UH724A UH727 UH727A UH734 UH734A UH748 UH748A UH760 UH760A	310876001 UH520 UH520A UH524 UH524A UH534 UH534A UH538 UH538A UH548 UH548A UH560 UH560A UH720 UH720A UH724 UH724A UH727 UH727A UH734 UH734A UH748 UH748A UH760 UH760A	5823-0004-000 UH520 UH520A UH524 UH524A UH534 UH534A UH538 UH538A UH548 UH548A UH560 UH560A UH720 UH720A UH724 UH724A UH727 UH727A UH748 UH748A UH760 UH760A	480100001 UH1020 UH1024 UH1027 UH1034 UH1048 UH1060 UH1520 UH1524 UH1527 UH1534 UH1548 UH1560 UH2034 UH2048 UH2060	480034002 UH2548 UH2560 UH3048 UH3060	
						5823-0004-005 UH734 UH734A			

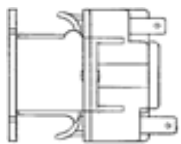
MEDH SERIES

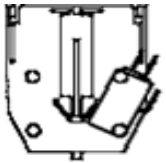
ELEMENT SMALL	ELEMENT LARGE	MOTOR	CONTACTOR		TRANSFORMER
					
1802-11001-000 DH1583CKD	1802-11001-001 DH1583CKD	3900-11002-000 DH1583CKD DH1021CKD DH1021D DH1521D DH1523D	5018-0006-007 DH1583CKD DH1521D DH1523D	5018-0006-009 DH1543CKD DH3043D 5018-0006-010 DH1021CKD	5814-0003-002 DH1543CKD DH3043D
1802-11001-002 DH1021CKD DH1021D DH1521D DH1523D DH1543CKD DH3043D	1802-11001-003 DH1021CKD DH1021D DH1521D DH1523D DH1543CKD DH3043D				
FAN BLADE	HI LIMIT	THERMOSTAT	CAPACITOR	GUARDS QTY.2 NEEDED	
					
1210-0098-001 ALL MODELS	410029000 ALL MODELS	5813-2059-000 ALL MODELS	1432-0002-003 ALL MODELS	2504-11005-000 ALL MODELS	
HANDLE	CART KNOB	THERMOSTAT KNOB	WHEEL	SHAFT CAP	AXEL SHAFT
					
2710-11001-000 ALL MODELS	3301-11003-000 ALL MODELS	3301-11018-002 ALL MODELS	6406-0002-000 ALL MODELS	1408-11002-000 ALL MODELS	5217-11001-000 ALL MODELS
CORD	FUSE	FUSE BLOCK	FAN RELAY	FAN DELAY	AUXILIARY SWITCH
					
SCS25064 DH1583CKD SCS10063 DH1021CKD SCS25124 DH1543CKD	2019-7008-077 DH1521D	480030007 DH1521D	5018-0007-000 DH1543CKD DH3043D	1414-2039-000 DH3043D	5216-10564-000 DH1521D

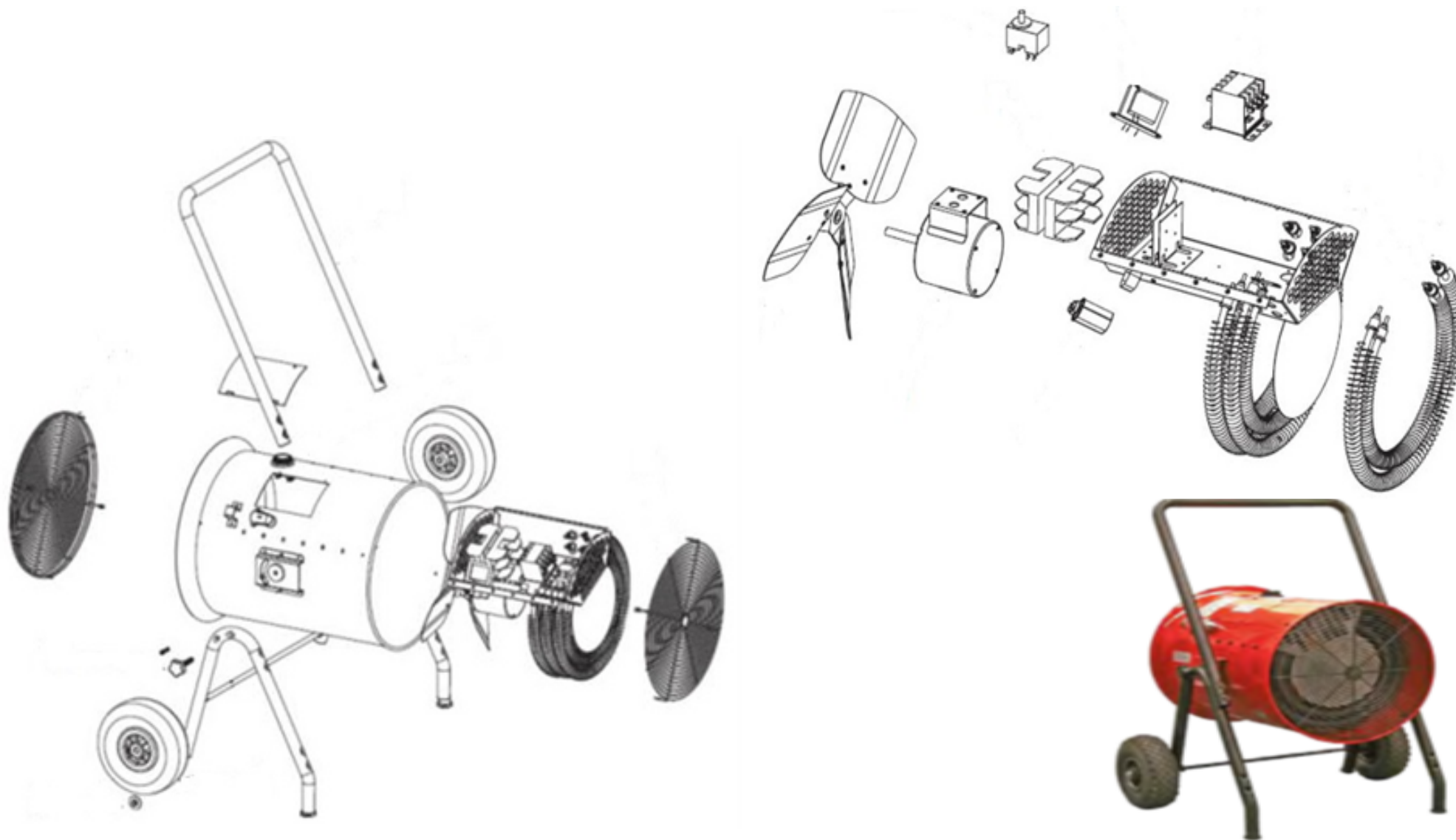

BSDH

MODEL	ELEMENT (11)	ELEMENT (12)	MOTOR (16)	CONTACTOR (20)
SDH3043	118-304793-011 (3)	118-304793-013 (3)	193-121843-232	072-304551-008
SDH3093	118-304793-012 (3)	118-304793-014 (3)	193-121843-233	072-304551-008
SDH4843	118-304793-011 (3)	118-304793-013 (6)	193-121843-232	072-304551-008 (2)
SDH4893	118-304793-012 (3)	118-304793-014 (6)	193-121843-233	072-304551-008 (2)
SDH6043	118-304793-011 (6)	118-304793-013 (6)	193-121843-232	072-304551-008 (2)
SDH6093	118-304793-012 (6)	118-304793-014 (6)	193-121843-233	072-304551-008 (2)
MODEL	TRANSFORMER (21)	FUSE BLOCK (80)	FUSE (81)	TERM. BLOCK (84)
SDH3043	315-304252-001	NA	NA	NA*
SDH3093	315-304252-003	NA	NA	NA*
SDH4843	315-304252-001	129-025643-001	128-026510-005 (3)	303-047468-004
SDH4893	315-304252-003	129-025643-001	128-026510-005 (3)	303-047468-004
SDH6043	315-304252-001	129-025643-001 (2)	128-026510-006 (6)	303-047468-004
SDH6093	315-304252-003	129-025643-001 (2)	128-026510-006 (6)	303-047468-004

PARTS COMMON TO ALL UNITS

TEMPERATURE CONTROL (18)	300-019560-002
HI-LIMIT (19)	300-049200-004
TOGGLE SWITCH (23)	292-046123-001
BLOWER ASSEMBLY (32)	021-304823-009
INLET & OUTLET GRILLE (33)	134-304780-002 (2)
CASTER/LOCKING (36)	375-122535-007
HANDLE-RIGHT SIDE (37)	139-304779-003
HANDLE-LEFT SIDE (38)	139-304479-004
SEMIPNEUMATIC WHEEL (45)	333-557518-004 (2)
PULLEY VAR. PITCH 7/8" (77)	225-305091-004
PULLEY VAR. PITCH 5/8" (78)	225-305091-003
PULLEY BELT (79)	017-049702-009
PILOT LIGHT-GREEN (86)	213-122066-043
PILOT LIGHT-AMBER (87)	213-122066-042
THERMOSTAT KNOB (94)	169-017949-004

NOTES:
 (#) QUANTITY REQ.
 * WIRED DIRECTLY TO CONTACTOR

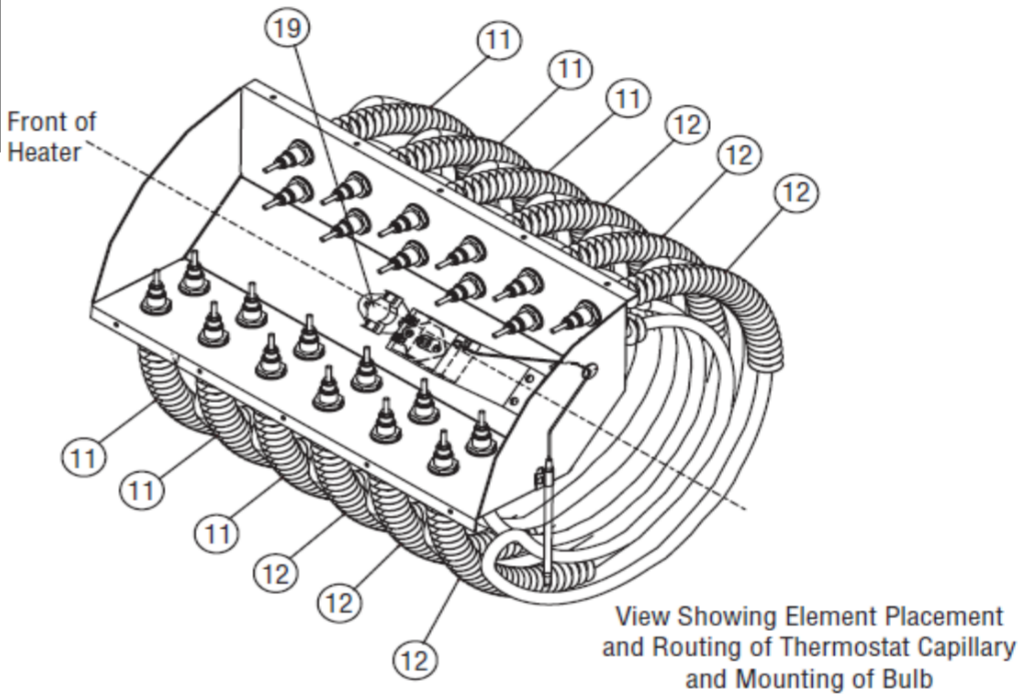
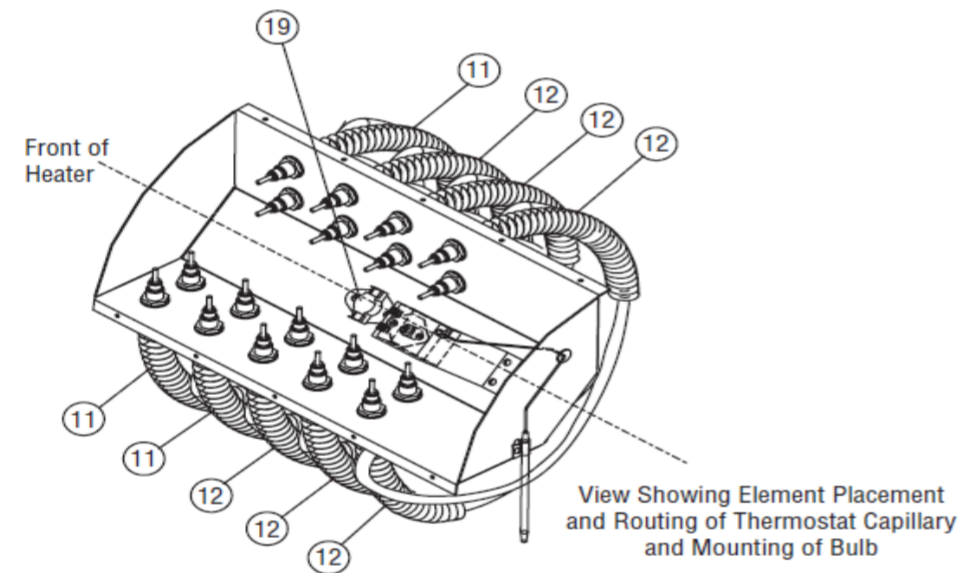
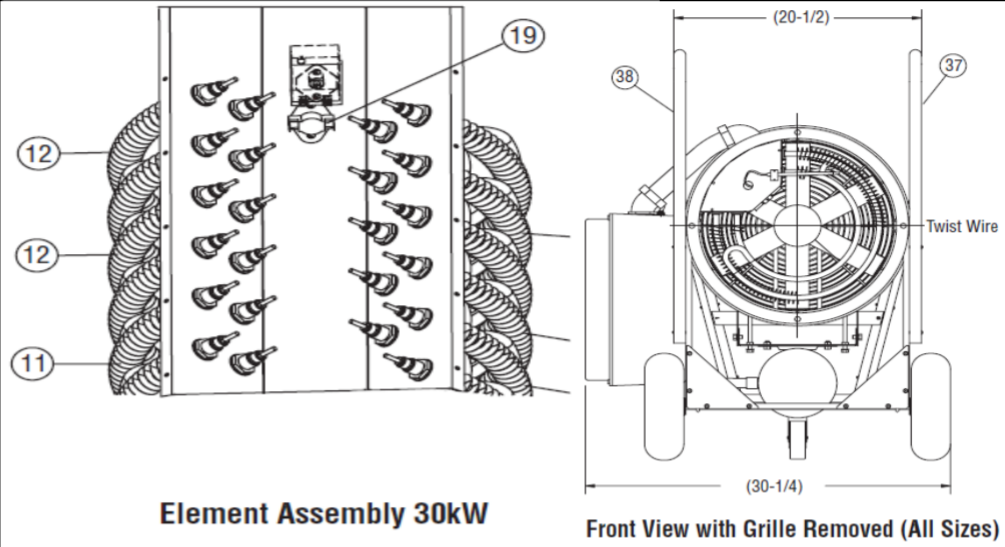





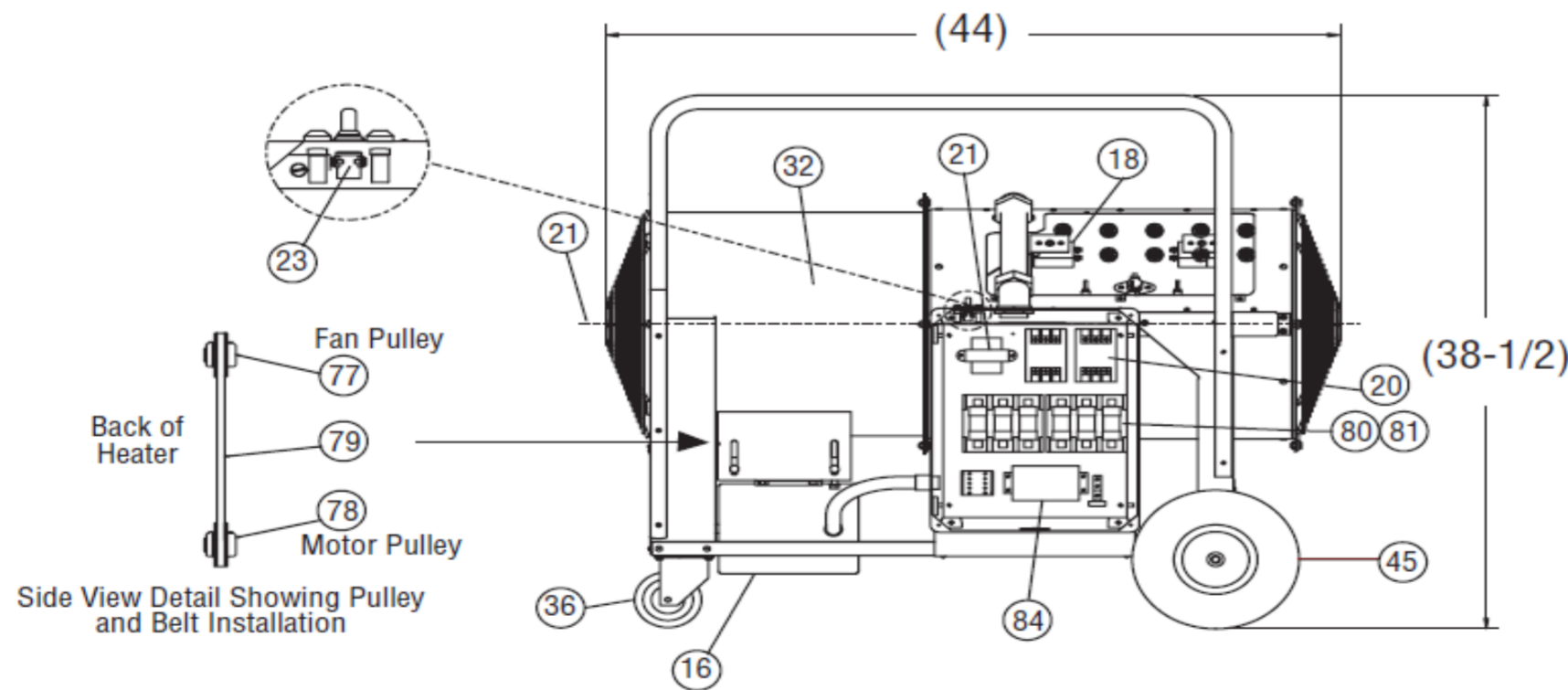

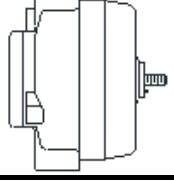
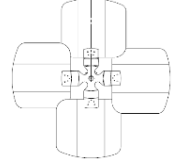
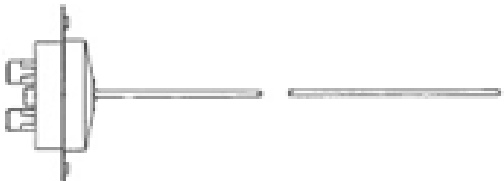
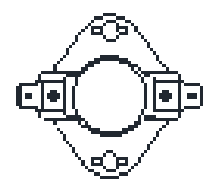
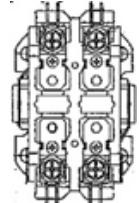
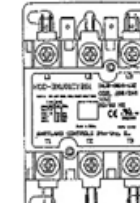
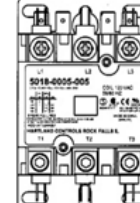
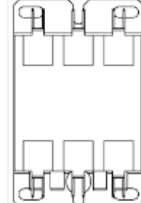
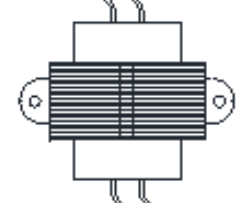
Element Assembly 48kW

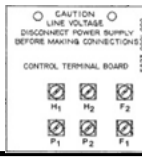
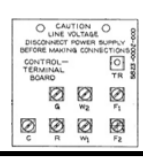
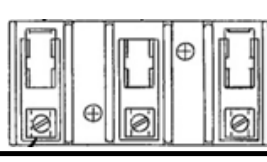
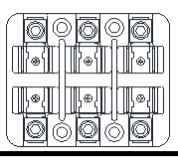

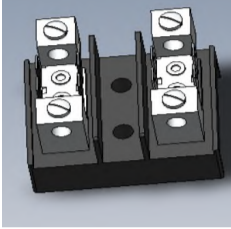

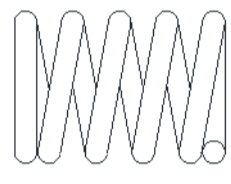
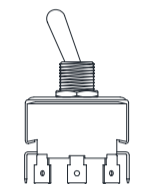



Element Assembly 60kW





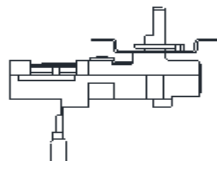
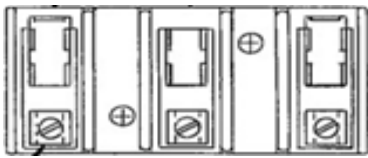
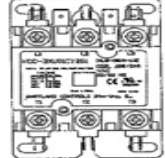
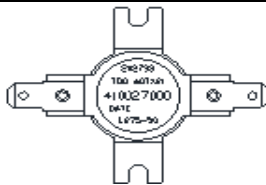
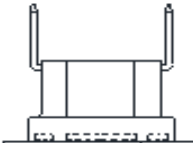
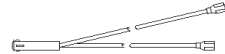





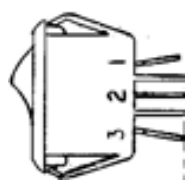

HUHAA SERIES						
ELEMENT				MOTOR		
QUANTITY OF ELEMENTS 3 THRU 10KW (3) 15 THRU 30KW (6) 40 & 50KW (9) 						
1802-0087-024 HUHAA320FC	1802-0087-031 HUHAA720FC	1802-0087-037 HUHAA1520FC	1802-0087-018 HUHAA3024FC	3900-2002-506 HUHAA320FC	3900-0347-005 HUHAA748FC	3900-0363-500 HUHAA2548AFC
1802-0087-000 HUHAA324FC	1802-0087-006 HUHAA724FC	1802-0087-012 HUHAA1524FC	1802-0087-019 HUHAA3048AFC	HUHAA324FC	HUHAA1048FC	HUHAA3048AFC
1802-0087-001 HUHAA327FC	1802-0087-007 HUHAA727FC	1802-0087-008 HUHAA1548FC	1802-0087-020 HUHAA4024FC	HUHAA520FC	3900-0361-500 HUHAA1520FC	3900-0350-000 HUHAA5020FC
1802-0087-002 HUHAA348FC	1802-0087-008 HUHAA727FC	1802-0087-026 HUHAA1548FC	1802-0087-021 HUHAA4048FC	HUHAA524FC	HUHAA1524FC	3900-0350-000 HUHAA4024FC
1802-0087-034 HUHAA520FC	1802-0087-008 HUHAA748FC	1802-0087-026 HUHAA2020FC	1802-0087-030 HUHAA5020FC	3900-2002-507 HUHAA327FC	3900-0361-501 HUHAA1548FC	3900-0350-000 HUHAA5024FC
1802-0087-035 HUHAA524FC	1802-0087-036 HUHAA1020FC	1802-0087-016 HUHAA2524FC	1802-0087-022 HUHAA5024FC	HUHAA348FC	3900-0362-002 HUHAA2020FC	3900-0350-001 HUHAA4048FC
1802-0087-004 HUHAA527FC	1802-0087-010 HUHAA1027FC	1802-0087-017 HUHAA2548AFC	1802-0087-023 HUHAA5048FC	HUHAA548FC	3900-0362-000 HUHAA2024FC	HUHAA5048FC
1802-0087-005 HUHAA548FC	1802-0087-011 HUHAA1048FC	1802-0087-028 HUHAA3020FC		3900-2014-004 HUHAA720FC	3900-0362-001 HUHAA2048FC	
	HUHAA2048FC			HUHAA724FC	3900-0364-000 HUHAA2524FC	
				HUHAA727FC	HUHAA3020FC	
				HUHAA1020FC	HUHAA3024FC	
				HUHAA1024FC	HUHAA3048AFC	
				HUHAA1027FC	HUHAA4048FC	
				HUHAA1048FC	HUHAA5020FC	
				HUHAA1520FC	HUHAA5024FC	
				HUHAA1548FC	HUHAA5048FC	
				HUHAA2020FC		
				HUHAA2024FC		
				HUHAA2048FC		
FAN BLADE				PROTECTOR LIMIT		FAN DELAY
						
1210-2000-000 HUHAA320FC	1210-0090-000 HUHAA720FC	1210-0098-000 HUHAA2524FC	4520-0011-000 HUHAA320FC	4520-0011-001 HUHAA720FC	4520-0011-002 HUHAA2524FC	4520-0010-000 ALL MODELS
HUHAA324FC	HUHAA724FC	HUHAA2548AFC	HUHAA324FC	HUHAA724FC	HUHAA2548AFC	
HUHAA327FC	HUHAA727FC	HUHAA3020FC	HUHAA327FC	HUHAA727FC	HUHAA3020FC	
HUHAA348FC	HUHAA748FC	HUHAA3024FC	HUHAA348FC	HUHAA748FC	HUHAA3024FC	
HUHAA520FC	HUHAA1020FC	HUHAA3048AFC	HUHAA520FC	HUHAA1020FC	HUHAA3048AFC	
HUHAA524FC	HUHAA1024FC	1210-11004-000 HUHAA4024FC	HUHAA524FC	HUHAA1024FC	HUHAA4024FC	
HUHAA527FC	HUHAA1027FC	HUHAA4048FC	HUHAA527FC	HUHAA1027FC	HUHAA4048FC	
HUHAA548FC	HUHAA1048FC	HUHAA5020FC	HUHAA548FC	HUHAA1048FC	HUHAA5020FC	
		HUHAA5024FC		HUHAA1520FC	HUHAA5024FC	
		HUHAA5048FC		HUHAA1524FC	HUHAA5048FC	
				HUHAA1548FC		
				HUHAA2020FC		
				HUHAA2024FC		
				HUHAA2048FC		
CONTACTOR				POWER TR		
						
30 AMP 5018-0003-000 HUHAA727FC	35 AMP 5018-0004-100 HUHAA348FC	40 AMP 5018-0005-004 HUHAA724FC	50 AMP 5018-0006-000 HUHAA2024FC	240/208V PR TO 24V SEC 5814-0003-000 HUHAA720FC	480V PR TO 24V SEC 5814-0003-002 HUHAA348FC	240V/208V PR TO 24V SEC 490026007 HUHAA4024FC
HUHAA1027FC	HUHAA548FC	HUHAA720FC	HUHAA3020FC	HUHAA724FC	HUHAA548FC	HUHAA5020FC
	HUHAA748FC	HUHAA1024FC	HUHAA5020FC	HUHAA1020FC	HUHAA748FC	HUHAA5024FC
	HUHAA1048FC	HUHAA1020FC	HUHAA5048FC	HUHAA1024FC	HUHAA1048FC	
	HUHAA1548FC	HUHAA1524FC		HUHAA1024FC	HUHAA1048FC	
		HUHAA1520FC	40 AMP 5018-11562-004 HUHAA4024FC	HUHAA1520FC	HUHAA1548FC	
		HUHAA2048FC	HUHAA5020FC	HUHAA1524FC	HUHAA2048FC	
		HUHAA2020FC	HUHAA5020FC	HUHAA2020FC	HUHAA2548AFC	
		HUHAA2524FC	HUHAA5020FC	HUHAA2024FC	HUHAA3048AFC	
		HUHAA2548AFC		HUHAA2524FC	HUHAA4048FC	
		HUHAA3024FC		HUHAA3020FC	HUHAA5048FC	
		HUHAA3048AFC		HUHAA3024FC		
		HUHAA4024FC		277V PR TO 24V SEC 5814-0003-001 HUHAA727FC		
		HUHAA4048FC		HUHAA1027FC		
		HUHAA5024FC				

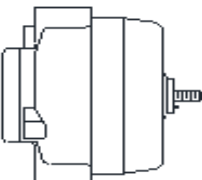
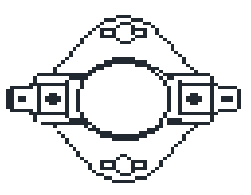
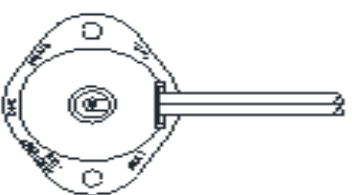
HUHAA CONTINUED						
CONTROL BOARD		POWER BLOCK		FUSE BLOCK	FUSE	
						
5823-0001-000 HUHAA320FC HUHAA324FC HUHAA327FC HUHAA520FC HUHAA524FC HUHAA527FC	5823-0002-000 HUHAA348FC HUHAA548FC HUHAA724FC HUHAA727FC HUHAA748FC HUHAA1020FC HUHAA1024FC HUHAA1027FC HUHAA1048FC HUHAA1520FC HUHAA1524FC HUHAA1548FC	5823-0004-000 HUHAA320FC HUHAA324FC HUHAA327FC HUHAA348FC HUHAA520FC HUHAA524FC HUHAA527FC HUHAA548FC HUHAA720FC	HUHAA724FC HUHAA727FC HUHAA748FC HUHAA1020FC HUHAA1024FC HUHAA1027FC HUHAA1048FC HUHAA1548FC HUHAA2048FC	5823-0004-001 HUHAA1524FC HUHAA2548AFC HUHAA3048AFC 5823-0004-002 HUHAA2020FC HUHAA2024FC HUHAA2524FC HUHAA4048FC HUHAA5048FC 5823-0004-003 HUHAA1520FC HUHAA3024FC 5823-0005-000 HUHAA3020FC HUHAA4024FC HUHAA5020FC HUHAA5024FC	2025-0002-000 HUHAA1520FC HUHAA2020FC 480030004 HUHAA2524FC HUHAA3020FC HUHAA3024FC HUHAA4024FC HUHAA5020FC HUHAA5024FC 2025-0001-000 HUHAA1520FC 2025-7004-000 HUHAA5048FC	2019-0007-010 HUHAA1520FC 2019-0007-008 HUHAA2020FC 2019-7008-077 HUHAA2524FC 2019-7008-080 HUHAA3020FC HUHAA5020FC 2019-7008-079 HUHAA3024FC HUHAA5024FC 2019-7008-078 HUHAA4024FC 2019-7002-008 HUHAA5048FC 2019-7002-012 HUHAA5048FC
						
		7.5-10KW 208 & 240V MODELS AFTER JAN 2024 5823-11012-000				
LOUVERS		LOUVER SPRING	HI/LOW SW.	CAPACITOR		
QUANTITY 3&5KW (5) 7 THRU 20KW (6) 25 THRU 50KW (9)						
3503-2004-106 HUHAA320FC HUHAA324FC HUHAA327FC HUHAA348FC HUHAA520FC HUHAA524FC HUHAA527FC HUHAA548FC	3503-2004-107 HUHAA720FC HUHAA724FC HUHAA727FC HUHAA748FC HUHAA1020FC HUHAA1024FC HUHAA1027FC HUHAA1048FC HUHAA1520FC HUHAA1524FC HUHAA1548FC HUHAA2020FC HUHAA2024FC HUHAA2048FC	3503-2004-108 HUHAA2524FC HUHAA2548AFC HUHAA3020FC HUHAA3024FC HUHAA3048AFC HUHAA4024FC HUHAA4048FC HUHAA5020FC HUHAA5024FC HUHAA5048FC	5208-7005-001 ALL MODELS	5216-2053-000 HUHAA2524FC HUHAA2548AFC HUHAA3020FC HUHAA3024FC HUHAA3048AFC HUHAA4024FC HUHAA4048FC HUHAA5020FC HUHAA5024FC HUHAA5048FC		1432-0002-003 HUHAA2020FC HUHAA2024FC HUHAA2048FC HUHAA2524FC 1432-11004-000 HUHAA2548AFC HUHAA3048AFC 1432-0002-001 HUHAA3020FC 1432-0002-004 HUHAA4024FC HUHAA4048FC HUHAA5020FC HUHAA5024FC HUHAA5048FC
HUHAA PRO SERIES						
SAME PARTS AS STOCK MODELS WITH ADDED DISCONNECT SWITCH, THERMOSTAT, & 24V CONTROL CIRCUIT						
MODEL	DISCONNTEC SWITCH	THERMOSTAT	TRANSFORMER	RELAY		
HUHAA320FC-PRO	5216-2036-000	UHMT1	5814-0003-000	5018-0003-000		
HUHAA324FC-PRO	5216-2036-000	UHMT1	5814-0003-000	5018-0003-000		
HUHAA348FC-PRO	5216-2036-000	UHMT1	5814-0003-002	5018-0004-100		
HUHAA520FC-PRO	5216-2036-000	UHMT1	5814-0003-000	5018-0003-000		
HUHAA524FC-PRO	5216-2036-000	UHMT1	5814-0003-000	5018-0003-000		
HUHAA548FC-PRO	5216-2036-000	UHMT1	5814-0003-002	5018-0004-100		
HUHAA720FC-PRO	5216-2039-000	UHMT1	5814-0003-000	5018-0003-000		
HUHAA724FC-PRO	5216-2039-000	UHMT1	5814-0003-000	5018-0003-000		
HUHAA748FC-PRO	5216-2036-000	UHMT1	5814-0003-002	5018-0004-100		
HUHAA1020FC-PRO	5216-2039-000	UHMT1	5814-0003-000	5018-0004-100		
HUHAA1024FC-PRO	5216-2039-000	UHMT1	5814-0003-000	5018-0003-000		
HUHAA1048FC-PRO	5216-2036-000	UHMT1	5814-0003-002	5018-0004-100		
MODEL	DISCONNTEC SWITCH	THERMOSTAT	TRANSFORMER	RELAY		
HUHAA320FCPRSS	5216-2036-000	1414-11050-000	5814-0003-000	5018-0003-000		
HUHAA324FCPRSS	5216-2036-000	1414-11050-000	5814-0003-000	5018-0003-000		
HUHAA348FCPRSS	5216-2036-000	1414-11050-000	5814-0003-002	5018-0004-100		
HUHAA520FCPRSS	5216-2036-000	1414-11050-000	5814-0003-000	5018-0003-000		
HUHAA524FCPRSS	5216-2036-000	1414-11050-000	5814-0003-000	5018-0003-000		
HUHAA548FCPRSS	5216-2036-000	1414-11050-000	5814-0003-002	5018-0004-100		
HUHAA720FCPRSS	5216-2039-000	1414-11050-000	5814-0003-000	5018-0003-000		
HUHAA724FCPRSS	5216-2039-000	1414-11050-000	5814-0003-000	5018-0003-000		
HUHAA748FCPRSS	5216-2036-000	1414-11050-000	5814-0003-002	5018-0004-100		
HUHAA1020FCPRSS	5216-2039-000	1414-11050-000	5814-0003-000	5018-0004-100		
HUHAA1024FCPRSS	5216-2039-000	1414-11050-000	5814-0003-000	5018-0003-000		
HUHAA1048FCPRSS	5216-2036-000	1414-11050-000	5814-0003-002	5018-0004-100		
UHMT1-S (ASSEMBLY 1-POLE)						
		5813-0038-003	THERMOSTAT			
		3301-11019-000	KNOB			



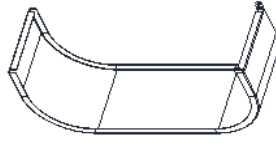
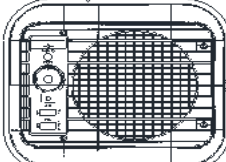
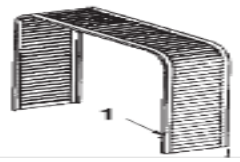
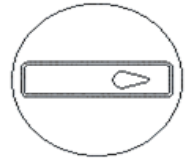
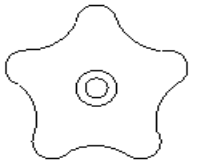

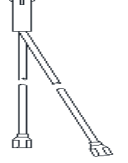

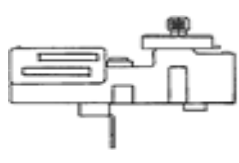
HUH524TA & HUH724ST SERIES

ELEMENT		MOTOR	FAN BLADE	KNOB	THERMOSTAT
					
302006807 HUH524TA HUH524TAB HUH524TAC	302006810 UH724ST UH724STA	3900-2008-000 HUH524TA HUH524TAB HUH524TAC UH724ST UH724STA	1210-2017-000 HUH524TA HUH524TAB HUH524TAC UH724ST UH724STA	3301-2014-006 HUH524TA HUH524TAB HUH524TAC UH724ST UH724STA	5813-2050-000 HUH524TA HUH524TAB HUH524TAC UH724ST UH724STA
POWER BLOCK		RELAY	HI LIMIT	FAN DELAY	LIGHT
					
5823-0004-005 HUH524TA HUH524TAB HUH524TAC	5823-0004-000 UH724ST UH724STA	5018-11006-000 UH724ST UH724STA	410027000 HUH524TA HUH524TAB HUH524TAC UH724ST UH724STA	410148000 HUH524TA HUH524TAB HUH524TAC UH724ST UH724STA	3510-2017-003 HUH524TAC UH724STA
LOUVERS		LOUVER SPRING	MT. BRACKET		
					
3503-2004-109 HUH524TA HUH524TAB HUH524TAC	UH724ST UH724STA	5208-7005-001 HUH524TA HUH524TAB HUH524TAC UH724ST UH724STA	310876001 HUH524TA HUH524TAB HUH524TAC UH724ST UH724STA		
					

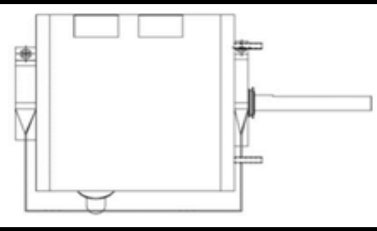
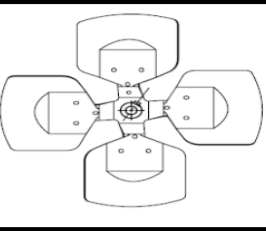
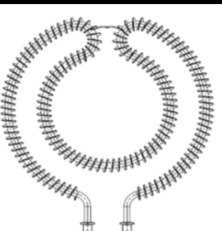
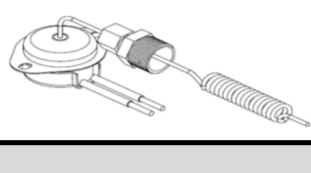
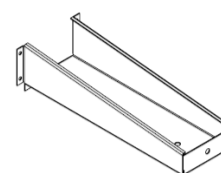
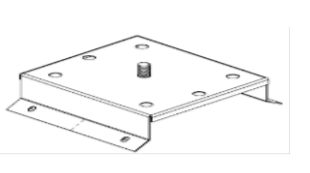
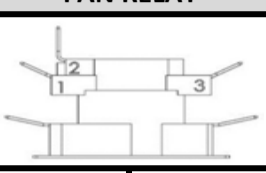
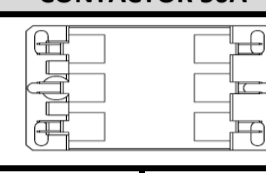
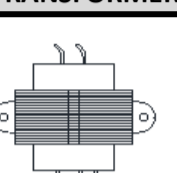
QPH4A & PH5 SERIES

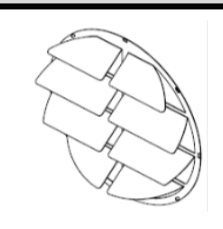
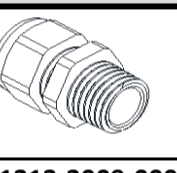
QPH4A & PH5 SERIES					
ROCKER SWITCH (2 REQ)	FAN BLADE		ELEMENT (3 REQ)		MOTOR
					
S99814893A000 PH5 PH5HW PH5HWA PH5HWAB PH5HWAC PH5HWAD PH4A PH4AB NPH4AB NPH4ABA	1210-2000-000 PH5 PH5HW PH5HWA PH5HWAB PH5HWAC PH5HWAD PH4 PH4A	1210-2000-001 PH4AB NPH4AB NPH4ABA	1802-0087-032 PH5 PH5HW PH5HWA PH5HWAB PH5HWAC PH5HWAD	1802-0087-038 PH4 PH4A PH4AB NPH4AB NPH4ABA	3900-2002-506 PH5 PH5HW PH5HWA PH5HWAB PH5HWAC PH5HWAD PH4 PH4A PH4AB NPH4AB NPH4ABA
FAN DELAY	MANUAL RESET			LIMIT	BUZZER
					
4520-0010-000 PH5HWAC PH5HWAD	4520-2017-000 PH5HWA PH5HWAB PH4A	4520-11004-000 PH4AB NPH4AB	4520-11004-002 PH5HWAC PH5HWAD NPH4ABA	4520-0011-000 PH5 PH5HW PH4	2714-11001-000 PH5HWAD
STAND	CONTROL COVER	GRILLE	GUARD	T'STAT KNOB	STAND KNOB (2 REQ)
					
5210-2000-002 PH5HWAB PH5HWAC PH5HWAD PH4A PH4AB NPH4AB NPH4ABA	1402-0336-000 PH5 PH5HW PH5HWA PH5HWAB PH5HWAC PH5HWAD PH4 PH4AB NPH4AB NPH4ABA	1402-2154-001 PH5HWAB PH5HWAC PH5HWAD PH4AB NPH4AB NPH4ABA	2504-0011-001 PH5 PH5HW PH5HWA PH5HWAB PH5HWAC PH5HWAD PH4 PH4AB NPH4AB NPH4ABA	3301-2012-001 PH5HWAB PH5HWAC PH5HWAD PH4AB NPH4AB NPH4ABA	3301-2018-000 PH5HWA PH5HWAB PH5HWAC PH5HWAD PH4AB NPH4AB NPH4ABA
LIGHT	CORD	THERMOSTAT			
					
3510-2007-000 PH5HWA PH5HWAB PH5HWAC PH5HWAD	1420-2028-000 PH4AB 1420-11012-000 NPH4AB NPH4ABA	5813-2018-000 PH5HWA PH5HWAB PH5HWAC PH5HWAD PH4A PH4AB NPH4AB NPH4ABA	5813-0047-000 PH5 PH5HW PH4		

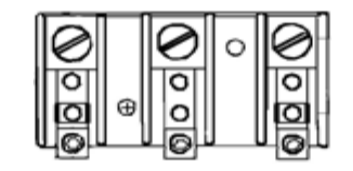
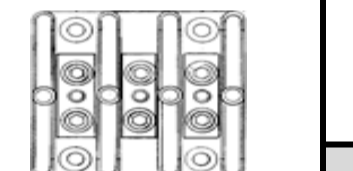
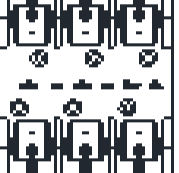





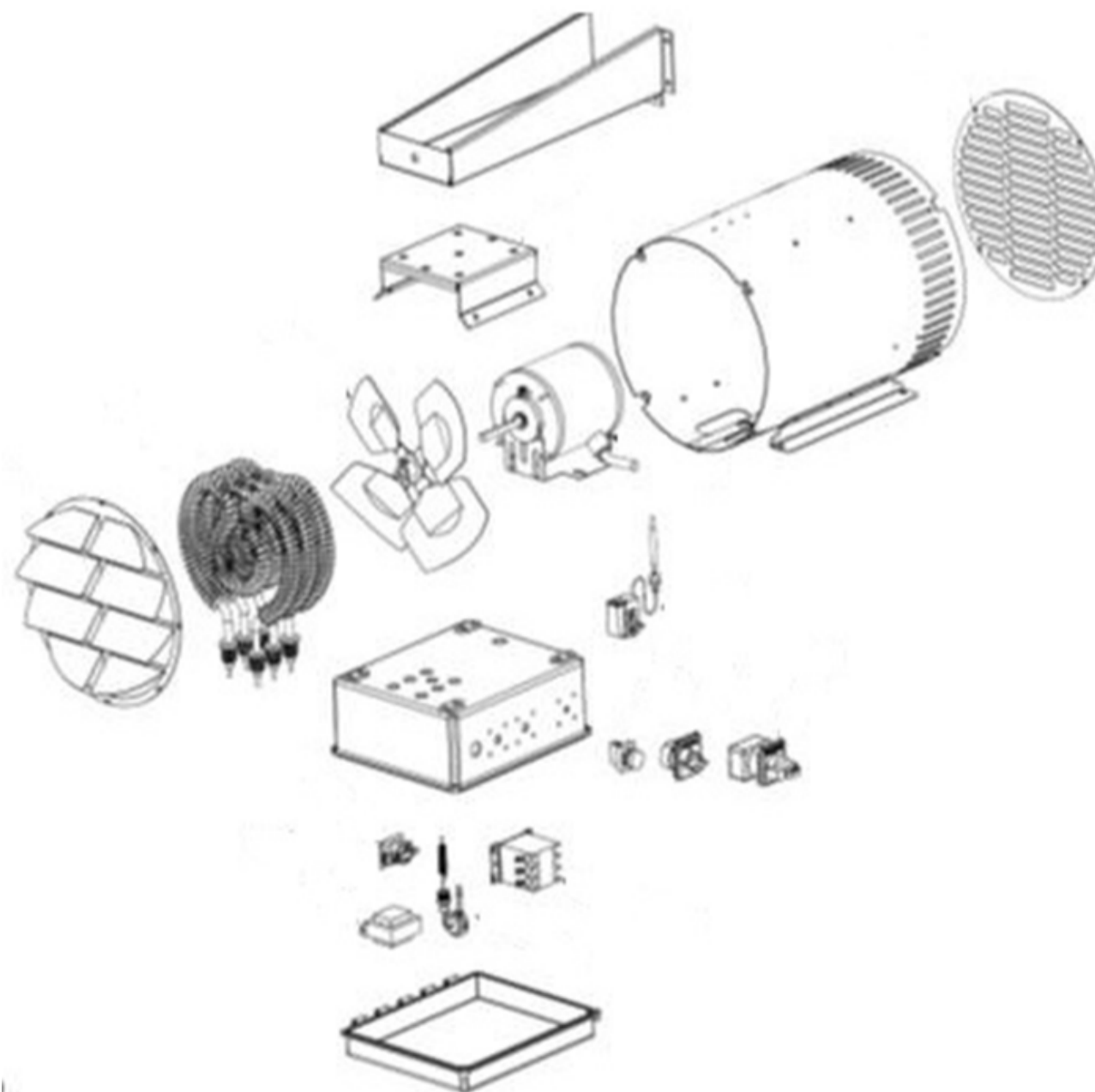

WD SERIES WASHDOWN UNIT HEATER (UNITS LARGER THAN 12.5KW CONTACT FACTORY FOR PART NUMBERS)

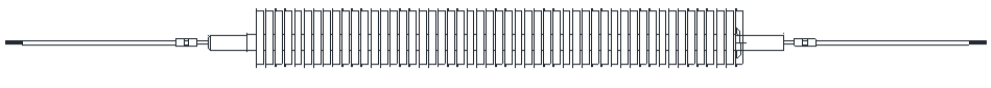
MOTOR		BLADE		ELEMENT	
				QUANTITY REQ 2KW (2) 3 THRU 12.5KW (3)	
208-240/480V 2KW-10KW MODELS 277V 3KW-10KW MODELS 120V 2-3KW MODELS 208-240/480V 12.5KW MODELS		10KW MODELS 10KW MODELS WITH EPOXY COATING 2-7.5KW MODELS 2-7.5KW MODELS WITH EPOXY COATING 12.5KW MODELS 12.5KW MODELS WITH EPOXY COATING			
LIMIT 2-10KW 12.5KW				2-3KW 120V 2-3KW 208V 2-3KW 240V 3KW 277V 3KW 480V 5KW 208V 5KW 240V 5KW 277V 5KW 480V 3PH 5KW 480V 1PH 7.5KW 208V 7.5KW 240V 7.5KW 277V 7.5KW 480V	
WALL/CEILING BRK 2-10KW MODELS 12.5KW MODELS		HAT BRACKET 2-10KW MODELS 12.5KW MODELS		1802-11012-001 1802-11012-002 1802-11012-003 1802-11012-004 1802-11012-004 1802-11012-005 1802-11012-006 1802-11012-007 1802-11012-007 1802-11012-008 1802-11012-011 1802-11012-012 1802-11012-009 1802-11012-008	
					
FAN RELAY 5018-11005-000		CONTACTOR 50A 5018-11005-001		TRANSFORMER 5018-0006-000	
					
BWD02112 BWD02212 BWD02812 BWD03112 BWD03212 BWD03232 BWD03432 BWD03712 BWD03812 BWD03832 BWD05212 BWD05232 BWD05412 BWD05432 BWD05712 BWD05812 BWD05832 BWD07212 BWD07232 BWD07412 BWD07432 BWD07712		BWD07812 BWD07832 BWD10212 BWD10232 BWD10412 BWD10432 BWD10712 BWD10832 BWD12212 BWD12232 BWD12432 BWD12812 BWD12832		208/240V TO 24V 277V TO 24V 480V TO 24V 208/240V TO 120V 277V TO 120V 480V TO 120V 5814-0003-000 5814-0003-001 5814-0003-002 5814-0003-003 5814-0003-005 5814-0003-006	
BWD07812 BWD07832 BWD10212 BWD10232 BWD10412 BWD10432 BWD10712 BWD10832 BWD12212 BWD12232 BWD12432 BWD12812 BWD12832		BWD05431 BWD07831		BWD05431 BWD07831	
GRILLE INLET 2-10KW MODELS 12.5KW MODELS		GRILLE OUTLET 2-10KW MODELS 12.5KW MODELS		STRAIGHT FITTING 1213-2009-000 ALL MODELS	
					
2504-11018-000 2504-11020-000		2504-11019-001 2504-11021-001		SILICONE SEAL PICTURE NOT AVAILABLE 5250-2001-000 ALL MODELS	
CAPACITOR 1432-0002-001		CAPACITOR 1432-0002-003		CAPACITOR 1432-0002-004	
					
BWD02112 BWD02212 BWD02812 BWD03112 BWD03212 BWD03232 BWD03432 BWD03712 BWD03812 BWD03832 BWD05212 BWD05232 BWD05412 BWD05432		BWD05812 BWD07212 BWD07232 BWD07412 BWD07432 BWD07812 BWD07832 BWD10212 BWD10232 BWD10412 BWD10432 BWD10832		BWD12212 BWD12232 BWD12432 BWD12812 BWD12832	
BWD05812 BWD07212 BWD07232 BWD07412 BWD07432 BWD07812 BWD07832 BWD10212 BWD10232 BWD10412 BWD10432 BWD10832		BWD12212 BWD12232 BWD12432 BWD12812 BWD12832		5823-0004-002 BWD02112 BWD02212 BWD02812 BWD03112 BWD03212 BWD03232 BWD03432 BWD03712 BWD03812 BWD03832 BWD05212 BWD05232 BWD05412 BWD05432 BWD05712 BWD05812 BWD05832 BWD07212 BWD07232 BWD07412 BWD07432	
480030004 BWD12212 BWD12812		FUSE BLOCK (2 REQ) 		FUSE 	
480030004 BWD12212 BWD12812		FUSE 35A 2019-11003-072 BWD12212 BWD12812		FUSE 45A 2019-11003-078 BWD12212	
FUSE 50A 2019-11003-079 BWD12812		TERMINAL BLOCK 		5823-2006-000 ALL MODELS	
THERMOSTAT SM/MD UNITS LRG UNITS		GASKET 5206-11009-000 5206-11010-000		KNOB 3301-11010-000	
5813-11010-000		5206-11009-000 5206-11010-000		3301-11010-000	
PILOT LIGHT 120V CONTROL 24V CONTROL		N/A		N/A	
3510-11009-001 3510-11009-000		N/A		N/A	
MODE SWITCH SM/MD UNITS LRG UNITS		5206-11009-000		PART OF SW. ASSM	
5216-11016-000 5216-11016-000		5206-11009-000		PART OF SW. ASSM	
DISCONNECT SWITCH 40AMP 60AMP 100AMP 125AMP		5206-11009-000		PART OF SW. ASSM	
5216-11017-000 5216-11017-001 5216-11017-002 5216-11017-003		5206-11009-000		PART OF SW. ASSM	
MANUAL RESET SM/MD UNITS LRG UNITS		N/A		N/A	
4520-11017-000 4520-11017-001		N/A		N/A	
EPOXY COATING CONTACT FACTORY					

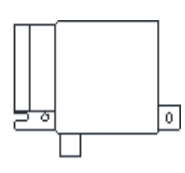
Factory Installed Accessories

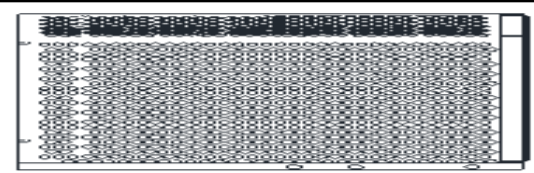
CATALOG NUMBER	DESCRIPTION
T	Thermostat
L	Pilot Light
S	Mode/Selector Switch
D	Disconnect Switch
E	Monel Element*
M	Manual Reset
P	Epoxy Coating

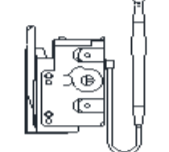

UCJ																
ELEMENT				LINEAR LIMIT			TR. RELAY									
																
1802-11021-003 J400B	1802-2044-011 J750B	1802-2044-014 J1007B	1802-2044-228 J1503B	4520-2018-000 J400B	4520-2018-003 J1000B	4520-2018-005 J1500B	5018-11003-003 J503B	410043007 J1006B								
1802-11021-001 J404B	1802-2044-210 J753B	1802-2044-016 J1008B	1802-2044-027 J1504B	J404B	J1003B	J1503B	J753B	J1256B								
1802-11021-000 J407B	1802-2044-009 J754B	1802-2044-023 J1250B	1802-2044-229 J1506B	J407B	J1004B	J1504B	J1003B	J1506B								
1802-11021-002 J408B	1802-2044-008 J757B	1802-2044-222 J1253B	1802-2044-026 J1507B	J408B	J1006B	J1506B	J1253B	J2006B								
1802-2044-043 J500B	1802-2044-010 J758B	1802-2044-021 J1254B	1802-2044-028 J1508B	4520-2018-001 J500B	J1007B	J1507B	J1503B									
1802-2044-202 J503B	1802-2044-017 J1000B	1802-2044-223 J1256B	1802-2044-234 J2003B	J503B	4520-2018-004 J1250B	4520-2018-006 J2003B	J2003B									
1802-2044-041 J504B	1802-2044-216 J1003B	1802-2044-020 J1257B	1802-2044-033 J2004B	J504B	J1253B	J2004B	J2004B									
1802-2044-040 J507B	1802-2044-015 J1004B	1802-2044-022 J1258B	1802-2044-235 J2006B	J507B	J1254B	J2006B	J2006B									
1802-2044-042 J508B	1802-2044-217 J1006B	1802-2044-029 J1500B	1802-2044-032 J2007B	J508B	J1256B	J2007B	J2007B									
			1802-2044-034 J2008B		J1257B	J2008B	J2008B									
					J1258B											
					J750B											
					J753B											
					J754B											
					J757B											
					J758B											
SWITCH		FRONT COVER			CONTROL COVER		THERMOSTAT									
																
5216-11007-000 J400B J404B J407B J408B J500B J504B J507B J508B J750B J754B J757B J758B J1000B J1004B		5216-2053-000 J503B J753B J1003B J1006B J1253B J1256B J1503B J1506B J2003B J2006B			1402-2192-006 J400B J404B J407B J408B 1402-2192-001 J500B J503B J504B J507B J508B 1402-2192-002 J750B J753B J754B J757B J758B		1402-2192-003 J1000B J1003B J1004B J1006B J1007B J1008B 1402-2192-004 J1250B J1253B J1254B J1256B J1257B J1258B		1402-2192-005 J1500B J1503B J1504B J1506B J1507B J1508B 1402-2192-007 J2003B J2004B J2006B J2007B J2008B		1402-11020-000 ALL MODELS			5813-11014-901 ALL MODELS		
																

ASL SERIES

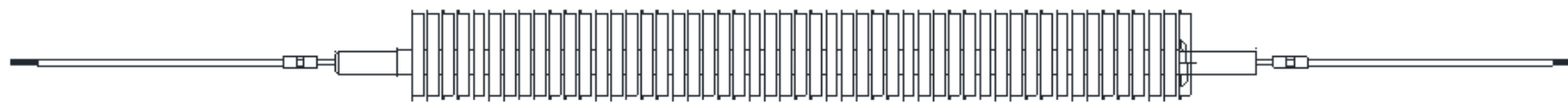

DISCRIPTION	PART NUMBERS					
	120V	208V	240V	277V	347V	600V
*ELEMENT (100 WATTS/FT)						
28" HEATER	1802-2001-047	1802-2001-048	1802-2001-049	NA	NA	NA
3'	1802-2001-053	1802-2001-054	1802-2001-055	1802-2001-056	NA	NA
4'	1802-2001-059	1802-2001-060	1802-2001-061	1802-2001-062	1802-2001-232	NA
5'	1802-2001-065	1802-2001-066	1802-2001-067	1802-2001-068	1802-2001-242	NA
6'	1802-2001-071	1802-2001-072	1802-2001-073	1802-2001-074	1802-2001-252	1802-2001-253
8'	NA	1802-2001-077	1802-2001-078	1802-2001-079	1802-2001-262	1802-2001-263
10'	NA	1802-2001-081	1802-2001-082	1802-2001-083	1802-2001-272	1802-2001-273
*ELEMENT (125 WATTS/FT)						
28" HEATER	1802-2001-085	1802-2001-086	1802-2001-048	1802-2001-049	NA	NA
3'	1802-2001-087	1802-2001-088	1802-2001-054	1802-2001-055	1802-2001-220	NA
4'	1802-2001-089	1802-2001-090	1802-2001-060	1802-2001-061	1802-2001-230	NA
5'	1802-2001-091	1802-2001-092	1802-2001-066	1802-2001-067	1802-2001-240	1802-2001-241
6'	1802-2001-093	1802-2001-094	1802-2001-072	1802-2001-073	1802-2001-250	1802-2001-251
8'	NA	1802-2001-095	1802-2001-077	1802-2001-078	1802-2001-260	1802-2001-261
10'	NA	1802-2001-096	1802-2001-081	1802-2001-082	1802-2001-270	1802-2001-271
*ELEMENT (150 WATTS/FT)						
28" HEATER	1802-2001-051	1802-2001-001	1802-2001-000	1802-2001-052	NA	NA
3'	1802-2001-057	1802-2001-007	1802-2001-006	1802-2001-058	1802-2001-218	NA
4'	1802-2001-063	1802-2001-013	1802-2001-012	1802-2001-064	1802-2001-228	NA
5'	1802-2001-069	1802-2001-019	1802-2001-018	1802-2001-070	1802-2001-238	1802-2001-239
6'	1802-2001-075	1802-2001-025	1802-2001-024	1802-2001-076	1802-2001-248	1802-2001-249
8'	NA	1802-2001-031	1802-2001-030	1802-2001-080	1802-2001-258	1802-2001-259
10'	NA	1802-2001-035	1802-2001-034	1802-2001-084	1802-2001-268	1802-2001-269
*ELEMENT (188 WATTS/FT)						
28" HEATER	1802-2001-005	1802-2001-002	1802-2001-001	1802-2001-000	NA	NA
3'	1802-2001-011	1802-2001-008	1802-2001-007	1802-2001-006	1802-2001-216	NA
4'	1802-2001-017	1802-2001-014	1802-2001-013	1802-2001-012	1802-2001-226	1802-2001-227
5'	1802-2001-023	1802-2001-020	1802-2001-019	1802-2001-018	1802-2001-236	1802-2001-237
6'	1802-2001-029	1802-2001-026	1802-2001-025	1802-2001-024	1802-2001-246	1802-2001-247
8'	NA	1802-2001-032	1802-2001-031	1802-2001-030	1802-2001-256	1802-2001-257
10'	NA	1802-2001-036	1802-2001-035	1802-2001-034	1802-2001-266	1802-2001-267
*ELEMENT (250 WATTS/FT)						
28" HEATER	1802-2001-004	1802-2001-003	1802-2001-002	1802-2001-001	1802-2001-202	NA
3'	1802-2001-010	1802-2001-009	1802-2001-008	1802-2001-007	1802-2001-214	NA
4'	1802-2001-016	1802-2001-015	1802-2001-014	1802-2001-013	1802-2001-224	1802-2001-225
5'	1802-2001-022	1802-2001-021	1802-2001-020	1802-2001-019	1802-2001-234	1802-2001-235
6'	1802-2001-028	1802-2001-027	1802-2001-026	1802-2001-025	1802-2001-244	1802-2001-245
8'	NA	1802-2001-033	1802-2001-032	1802-2001-031	1802-2001-254	1802-2001-255
10'	NA	1802-2001-037	1802-2001-036	1802-2001-035	1802-2001-264	1802-2001-265

* 1, 2 OR 3 ELEMENTS MAY BE REQUIRED. VOLTAGE AND WATTAGE ARE STAMPED ON END OF ELEMENTS. DIVIDE THE WATTAGE BY THE HEATER LENGTH (FEET) TO DETERMINE WATTS/FOOT OF ELEMENT. THEN USE THIS DATA TO DETERMINE PART NUMBER OF HEATING ELEMENT.

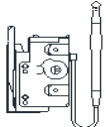
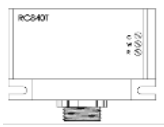
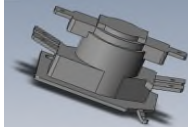

DISCRIPTION	PART NUMBERS					
	120V	208V	240V	277V	347V	600V
LINEAR LIMIT						
28" HEATER	4520-0007-007	4520-0007-007	4520-0007-007	4520-0007-007	4520-0007-007	4520-0007-007
3'	4520-0007-008	4520-0007-008	4520-0007-008	4520-0007-008	4520-0007-008	4520-0007-008
4'	4520-0007-009	4520-0007-009	4520-0007-009	4520-0007-009	4520-0007-009	4520-0007-009
5'	4520-0007-010	4520-0007-010	4520-0007-010	4520-0007-010	4520-0007-010	4520-0007-010
6'	4520-0007-011	4520-0007-011	4520-0007-011	4520-0007-011	4520-0007-011	4520-0007-011
8'	NA	4520-0007-012	4520-0007-012	4520-0007-012	4520-0007-012	4520-0007-012
10'	NA	4520-0007-013	4520-0007-013	4520-0007-013	4520-0007-013	4520-0007-013
						
DISCONNECT SW.	THERMOSTAT	TRANSFORMER		POWER RELAY		
410170001	2-STAGE 5813-0023-000 SINGLE POLE 5813-11014-901	120V 5018-11003-000 208/240V 5018-11003-001	277V 5018-11003-002 347V 5018-11003-003	24V 410171001 120V 410171002	208/240V/277V 410171003	

BDBSL SERIES

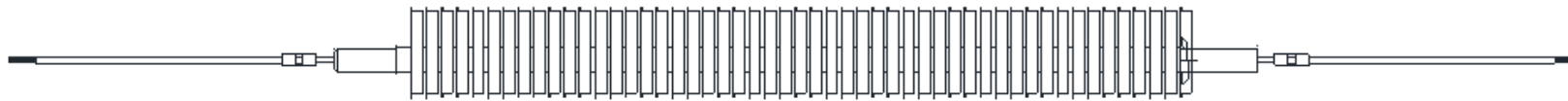

DISCRIPTION	PART NUMBERS					
	120V	208V	240V	277V	347V	600V
*ELEMENT (100 WATTS/FT)						
28" HEATER	1802-2001-047	1802-2001-048	1802-2001-049	NA	NA	NA
3'	1802-2001-053	1802-2001-054	1802-2001-055	1802-2001-056	NA	NA
4'	1802-2001-059	1802-2001-060	1802-2001-061	1802-2001-062	1802-2001-232	NA
5'	1802-2001-065	1802-2001-066	1802-2001-067	1802-2001-068	1802-2001-242	NA
6'	1802-2001-071	1802-2001-072	1802-2001-073	1802-2001-074	1802-2001-252	1802-2001-253
8'	NA	1802-2001-077	1802-2001-078	1802-2001-079	1802-2001-262	1802-2001-263
10'	NA	1802-2001-081	1802-2001-082	1802-2001-083	1802-2001-272	1802-2001-273
*ELEMENT (125 WATTS/FT)						
28" HEATER	1802-2001-085	1802-2001-086	1802-2001-048	1802-2001-049	NA	NA
3'	1802-2001-087	1802-2001-088	1802-2001-054	1802-2001-055	1802-2001-220	NA
4'	1802-2001-089	1802-2001-090	1802-2001-060	1802-2001-061	1802-2001-230	NA
5'	1802-2001-091	1802-2001-092	1802-2001-066	1802-2001-067	1802-2001-240	1802-2001-241
6'	1802-2001-093	1802-2001-094	1802-2001-072	1802-2001-073	1802-2001-250	1802-2001-251
8'	NA	1802-2001-095	1802-2001-077	1802-2001-078	1802-2001-260	1802-2001-261
10'	NA	1802-2001-096	1802-2001-081	1802-2001-082	1802-2001-270	1802-2001-271
*ELEMENT (150 WATTS/FT)						
28" HEATER	1802-2001-051	1802-2001-001	1802-2001-000	1802-2001-052	NA	NA
3'	1802-2001-057	1802-2001-007	1802-2001-006	1802-2001-058	1802-2001-218	NA
4'	1802-2001-063	1802-2001-013	1802-2001-012	1802-2001-064	1802-2001-228	NA
5'	1802-2001-069	1802-2001-019	1802-2001-018	1802-2001-070	1802-2001-238	1802-2001-239
6'	1802-2001-075	1802-2001-025	1802-2001-024	1802-2001-076	1802-2001-248	1802-2001-249
8'	NA	1802-2001-031	1802-2001-030	1802-2001-080	1802-2001-258	1802-2001-259
10'	NA	1802-2001-035	1802-2001-034	1802-2001-084	1802-2001-268	1802-2001-269
*ELEMENT (188 WATTS/FT)						
24" HEATER	1802-2001-038	1802-2001-039	1802-2001-040	1802-2001-041	1802-2001-200	NA
28"	1802-2001-005	1802-2001-002	1802-2001-001	1802-2001-000	NA	NA
3'	1802-2001-011	1802-2001-008	1802-2001-007	1802-2001-006	1802-2001-216	NA
4'	1802-2001-017	1802-2001-014	1802-2001-013	1802-2001-012	1802-2001-226	1802-2001-227
5'	1802-2001-023	1802-2001-020	1802-2001-019	1802-2001-018	1802-2001-236	1802-2001-237
6'	1802-2001-029	1802-2001-026	1802-2001-025	1802-2001-024	1802-2001-246	1802-2001-247
8'	NA	1802-2001-032	1802-2001-031	1802-2001-030	1802-2001-256	1802-2001-257
10'	NA	1802-2001-036	1802-2001-035	1802-2001-034	1802-2001-266	1802-2001-267
LINEAR LIMIT		DISCONNECT SW.	THERMOSTAT			
28" HEATER	4520-0007-007	410170001	2-STAGE	SINGLE POLE		
3'	4520-0007-008		5813-0023-000	410129002		
4'	4520-0007-009					
5'	4520-0007-010					
6'	4520-0007-011					
8'	4520-0007-012					
10'	4520-0007-013					

ICST SERIES

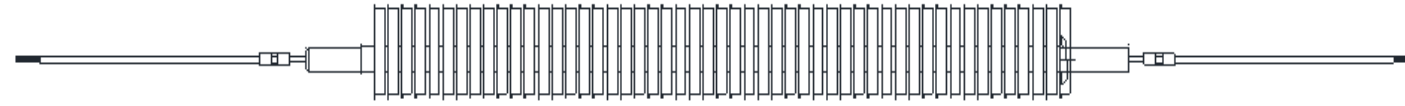

DISCRIPTION	PART NUMBERS					
	120V	208V	240V	277V	347V	600V
*ELEMENT (125 WATTS/FT)						
28" HEATER	1802-2001-085	1802-2001-086	1802-2001-048	1802-2001-049	NA	NA
3'	1802-2001-087	1802-2001-088	1802-2001-054	1802-2001-055	1802-2001-220	NA
4'	1802-2001-089	1802-2001-090	1802-2001-060	1802-2001-061	1802-2001-230	NA
5'	1802-2001-091	1802-2001-092	1802-2001-066	1802-2001-067	1802-2001-240	1802-2001-241
6'	1802-2001-093	1802-2001-094	1802-2001-072	1802-2001-073	1802-2001-250	1802-2001-251
8'	NA	1802-2001-095	1802-2001-077	1802-2001-078	1802-2001-260	1802-2001-261
10'	NA	1802-2001-096	1802-2001-081	1802-2001-082	1802-2001-270	1802-2001-271
*ELEMENT (188 WATTS/FT)						
28" HEATER	1802-2001-005	1802-2001-002	1802-2001-001	1802-2001-000	NA	NA
3'	1802-2001-011	1802-2001-008	1802-2001-007	1802-2001-006	1802-2001-216	NA
4'	1802-2001-017	1802-2001-014	1802-2001-013	1802-2001-012	1802-2001-226	1802-2001-227
5'	1802-2001-023	1802-2001-020	1802-2001-019	1802-2001-018	1802-2001-236	1802-2001-237
6'	1802-2001-029	1802-2001-026	1802-2001-025	1802-2001-024	1802-2001-246	1802-2001-247
8'	NA	1802-2001-032	1802-2001-031	1802-2001-030	1802-2001-256	1802-2001-257
10'	NA	1802-2001-036	1802-2001-035	1802-2001-034	1802-2001-266	1802-2001-267
*ELEMENT (250 WATTS/FT)						
28" HEATER	1802-2001-004	1802-2001-003	1802-2001-002	1802-2001-001	1802-2001-202	NA
3'	1802-2001-010	1802-2001-009	1802-2001-008	1802-2001-007	1802-2001-214	NA
4'	1802-2001-016	1802-2001-015	1802-2001-014	1802-2001-013	1802-2001-224	1802-2001-225
5'	1802-2001-022	1802-2001-021	1802-2001-020	1802-2001-019	1802-2001-234	1802-2001-235
6'	1802-2001-028	1802-2001-027	1802-2001-026	1802-2001-025	1802-2001-244	1802-2001-245
8'	NA	1802-2001-033	1802-2001-032	1802-2001-031	1802-2001-254	1802-2001-255
10'	NA	1802-2001-037	1802-2001-036	1802-2001-035	1802-2001-264	1802-2001-265

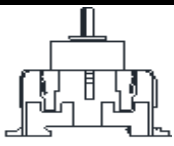
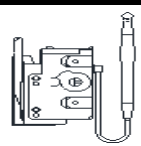
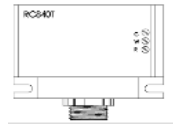
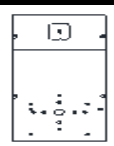
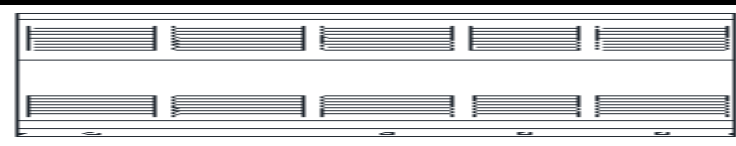

DISCRIPTION	PART NUMBERS					
	120V	208V	240V	277V	347V	600V
LINEAR LIMIT						
28" HEATER	4520-2018-001	4520-2018-001	4520-2018-001	4520-2018-001	4520-2018-001	4520-2018-001
3'	4520-2018-002	4520-2018-002	4520-2018-002	4520-2018-002	4520-2018-002	4520-2018-002
4'	4520-2018-003	4520-2018-003	4520-2018-003	4520-2018-003	4520-2018-003	4520-2018-003
5'	4520-2018-004	4520-2018-004	4520-2018-004	4520-2018-004	4520-2018-004	4520-2018-004
6'	4520-2018-005	4520-2018-005	4520-2018-005	4520-2018-005	4520-2018-005	4520-2018-005
8'	NA	4520-2018-006	4520-2018-006	4520-2018-006	4520-2018-006	4520-2018-006
10'	NA	4520-2018-007	4520-2018-007	4520-2018-007	4520-2018-007	4520-2018-007
DISCONNECT SW.	THERMOSTAT	TRANSFORMER RELAY		J-BOX COVER	FRONT COVER	
						
DS	2-STAGE 5813-0023-000 SINGLE POLE 5813-11014-901	120V 5018-11003-000 208/240V 5018-11003-001	277V 5018-11003-002 347V 5018-11003-003	ALL MODELS 1402-2250-000	1402-2251-000 1402-2251-001 1402-2251-002 1402-2251-003 1402-2251-004 1402-2251-005 1402-2251-006	28" 3' 4' 5' 6' 8' 10'

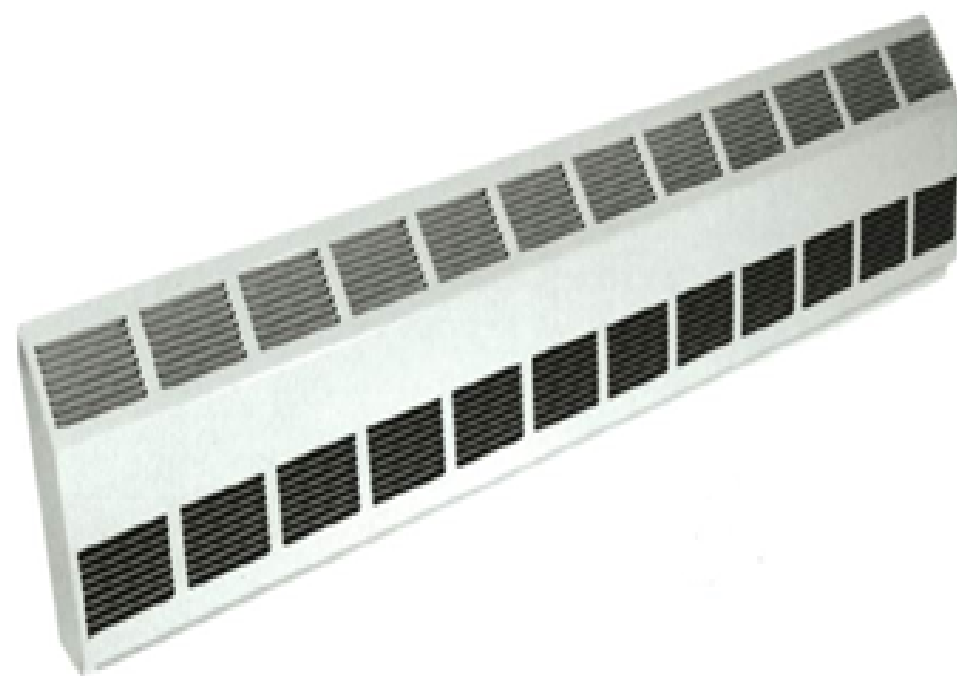
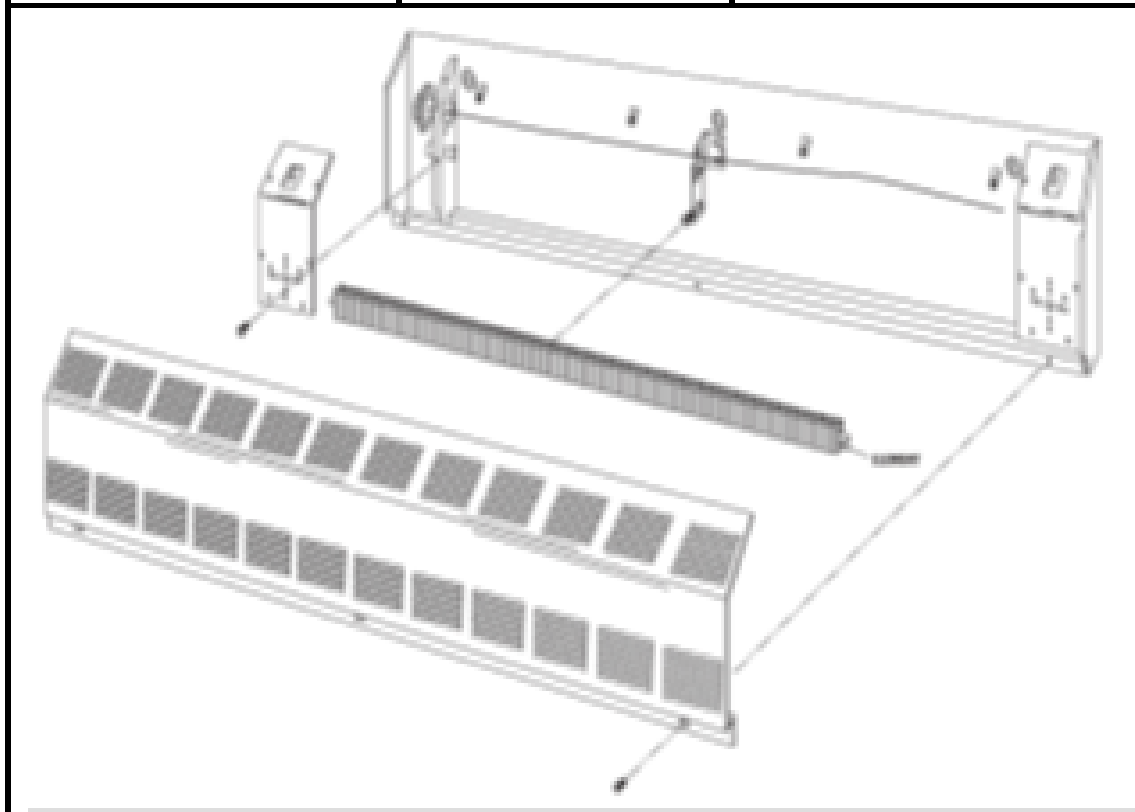

CSL & CPL SERIES

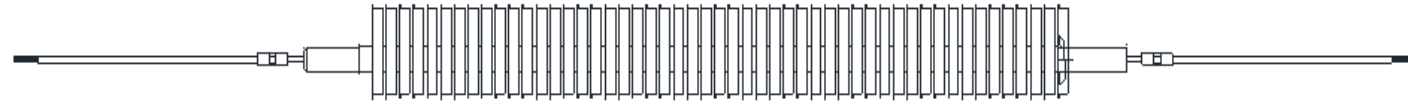

DISCRIPTION	PART NUMBERS					
	120V	208V	240V	277V	347V	600V
*ELEMENT (125 WATTS/FT)						
28" HEATER	1802-2001-085	1802-2001-086	1802-2001-048	1802-2001-049	NA	NA
3'	1802-2001-087	1802-2001-088	1802-2001-054	1802-2001-055	1802-2001-220	NA
4'	1802-2001-089	1802-2001-090	1802-2001-060	1802-2001-061	1802-2001-230	NA
5'	1802-2001-091	1802-2001-092	1802-2001-066	1802-2001-067	1802-2001-240	1802-2001-241
6'	1802-2001-093	1802-2001-094	1802-2001-072	1802-2001-073	1802-2001-250	1802-2001-251
8'	NA	1802-2001-095	1802-2001-077	1802-2001-078	1802-2001-260	1802-2001-261
10'	NA	1802-2001-096	1802-2001-081	1802-2001-082	1802-2001-270	1802-2001-271
*ELEMENT (188 WATTS/FT)						
28" HEATER	1802-2001-005	1802-2001-002	1802-2001-001	1802-2001-000	NA	NA
3'	1802-2001-011	1802-2001-008	1802-2001-007	1802-2001-006	1802-2001-216	NA
4'	1802-2001-017	1802-2001-014	1802-2001-013	1802-2001-012	1802-2001-226	1802-2001-227
5'	1802-2001-023	1802-2001-020	1802-2001-019	1802-2001-018	1802-2001-236	1802-2001-237
6'	1802-2001-029	1802-2001-026	1802-2001-025	1802-2001-024	1802-2001-246	1802-2001-247
8'	NA	1802-2001-032	1802-2001-031	1802-2001-030	1802-2001-256	1802-2001-257
10'	NA	1802-2001-036	1802-2001-035	1802-2001-034	1802-2001-266	1802-2001-267
*ELEMENT (250 WATTS/FT)						
28" HEATER	1802-2001-004	1802-2001-003	1802-2001-002	1802-2001-001	1802-2001-202	NA
3'	1802-2001-010	1802-2001-009	1802-2001-008	1802-2001-007	1802-2001-214	NA
4'	1802-2001-016	1802-2001-015	1802-2001-014	1802-2001-013	1802-2001-224	1802-2001-225
5'	1802-2001-022	1802-2001-021	1802-2001-020	1802-2001-019	1802-2001-234	1802-2001-235
6'	1802-2001-028	1802-2001-027	1802-2001-026	1802-2001-025	1802-2001-244	1802-2001-245
8'	NA	1802-2001-033	1802-2001-032	1802-2001-031	1802-2001-254	1802-2001-255
10'	NA	1802-2001-037	1802-2001-036	1802-2001-035	1802-2001-264	1802-2001-265

* 1,2 OR 3 ELEMENTS MAY BE REQUIRED. VOLTAGE AND WATTAGE ARE STAMPED ON END OF ELEMENTS. DIVIDE THE WATTAGE BY THE HEATER LENGTH (FEET) TO DETERMINE WATTS/FOOT OF ELEMENT. THEN USE THIS DATA TO DETERMINE PART NUMBER OF HEATING ELEMENT.



DISCRIPTION	PART NUMBERS					
	120V	208V	240V	277V	347V	600V
LINEAR LIMIT						
28" HEATER	4520-0007-007	4520-0007-007	4520-0007-007	4520-0007-007	4520-0007-007	4520-0007-007
3'	4520-0007-008	4520-0007-008	4520-0007-008	4520-0007-008	4520-0007-008	4520-0007-008
4'	4520-0007-009	4520-0007-009	4520-0007-009	4520-0007-009	4520-0007-009	4520-0007-009
5'	4520-0007-010	4520-0007-010	4520-0007-010	4520-0007-010	4520-0007-010	4520-0007-010
6'	4520-0007-011	4520-0007-011	4520-0007-011	4520-0007-011	4520-0007-011	4520-0007-011
8'	NA	4520-0007-012	4520-0007-012	4520-0007-012	4520-0007-012	4520-0007-012
10'	NA	4520-0007-013	4520-0007-013	4520-0007-013	4520-0007-013	4520-0007-013

DISCONNECT SW.	THERMOSTAT	TRANSFORMER RELAY	24V TRANSFORMER
410170001	2-STAGE 5813-0023-000 SINGLE POLE 5813-11014-901	120V 5018-11003-000 208/240V 5018-11003-001 277V 5018-11003-002 347V 5018-11003-003	208/240V PRIMARY 490026001 277V PRIMARY 490026002
CIRCUIT BREAKER	POWER RELAY		
2-POLE, 30A 1226-7009-013 2-POLE, 60A 1226-7009-010 3-POLE, 30A 1226-7009-005 3-POLE, 60A 1226-7009-002	24V 410171001 120V 410171002 208/240V 410171003	277V 410171003	

ASLC SERIES

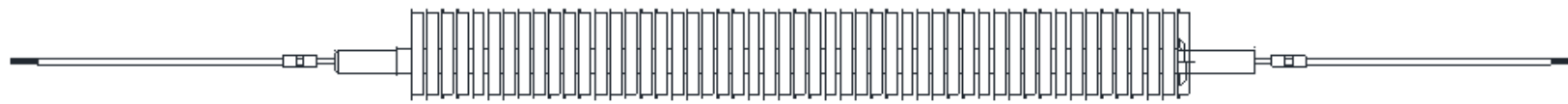

DISCRIPTION	PART NUMBERS					
	120V	208V	240V	277V	347V	600V
*ELEMENT (100 WATTS/FT)						
28" HEATER	1802-2001-047	1802-2001-048	1802-2001-049	NA	NA	NA
3'	1802-2001-053	1802-2001-054	1802-2001-055	1802-2001-056	NA	NA
4'	1802-2001-059	1802-2001-060	1802-2001-061	1802-2001-062	1802-2001-232	NA
5'	1802-2001-065	1802-2001-066	1802-2001-067	1802-2001-068	1802-2001-242	NA
6'	1802-2001-071	1802-2001-072	1802-2001-073	1802-2001-074	1802-2001-252	1802-2001-253
8'	NA	1802-2001-077	1802-2001-078	1802-2001-079	1802-2001-262	1802-2001-263
10'	NA	1802-2001-081	1802-2001-082	1802-2001-083	1802-2001-272	1802-2001-273
*ELEMENT (125 WATTS/FT)						
28" HEATER	1802-2001-085	1802-2001-086	1802-2001-048	1802-2001-049	NA	NA
3'	1802-2001-087	1802-2001-088	1802-2001-054	1802-2001-055	1802-2001-220	NA
4'	1802-2001-089	1802-2001-090	1802-2001-060	1802-2001-061	1802-2001-230	NA
5'	1802-2001-091	1802-2001-092	1802-2001-066	1802-2001-067	1802-2001-240	1802-2001-241
6'	1802-2001-093	1802-2001-094	1802-2001-072	1802-2001-073	1802-2001-250	1802-2001-251
8'	NA	1802-2001-095	1802-2001-077	1802-2001-078	1802-2001-260	1802-2001-261
10'	NA	1802-2001-096	1802-2001-081	1802-2001-082	1802-2001-270	1802-2001-271
*ELEMENT (150 WATTS/FT)						
28" HEATER	1802-2001-051	1802-2001-001	1802-2001-000	1802-2001-052	NA	NA
3'	1802-2001-057	1802-2001-007	1802-2001-006	1802-2001-058	1802-2001-218	NA
4'	1802-2001-063	1802-2001-013	1802-2001-012	1802-2001-064	1802-2001-228	NA
5'	1802-2001-069	1802-2001-019	1802-2001-018	1802-2001-070	1802-2001-238	1802-2001-239
6'	1802-2001-075	1802-2001-025	1802-2001-024	1802-2001-076	1802-2001-248	1802-2001-249
8'	NA	1802-2001-031	1802-2001-030	1802-2001-080	1802-2001-258	1802-2001-259
10'	NA	1802-2001-035	1802-2001-034	1802-2001-084	1802-2001-268	1802-2001-269
*ELEMENT (188 WATTS/FT)						
24" HEATER	1802-2001-038	1802-2001-039	1802-2001-040	1802-2001-041	1802-2001-200	NA
28"	1802-2001-005	1802-2001-002	1802-2001-001	1802-2001-000	NA	NA
3'	1802-2001-011	1802-2001-008	1802-2001-007	1802-2001-006	1802-2001-216	NA
4'	1802-2001-017	1802-2001-014	1802-2001-013	1802-2001-012	1802-2001-226	1802-2001-227
5'	1802-2001-023	1802-2001-020	1802-2001-019	1802-2001-018	1802-2001-236	1802-2001-237
6'	1802-2001-029	1802-2001-026	1802-2001-025	1802-2001-024	1802-2001-246	1802-2001-247
8'	NA	1802-2001-032	1802-2001-031	1802-2001-030	1802-2001-256	1802-2001-257
10'	NA	1802-2001-036	1802-2001-035	1802-2001-034	1802-2001-266	1802-2001-267
*ELEMENT (250 WATTS/FT)						
28" HEATER	1802-2001-004	1802-2001-003	1802-2001-002	1802-2001-001	1802-2001-202	NA
3'	1802-2001-010	1802-2001-009	1802-2001-008	1802-2001-007	1802-2001-214	NA
4'	1802-2001-016	1802-2001-015	1802-2001-014	1802-2001-013	1802-2001-224	1802-2001-225
5'	1802-2001-022	1802-2001-021	1802-2001-020	1802-2001-019	1802-2001-234	1802-2001-235
6'	1802-2001-028	1802-2001-027	1802-2001-026	1802-2001-025	1802-2001-244	1802-2001-245
8'	NA	1802-2001-033	1802-2001-032	1802-2001-031	1802-2001-254	1802-2001-255
10'	NA	1802-2001-037	1802-2001-036	1802-2001-035	1802-2001-264	1802-2001-265
LINEAR LIMIT		DISCONNECT SW.		THERMOSTAT		P.E. SWITCH
28" HEATER	4520-0007-007	410170001		2-STAGE		410172001
3'	4520-0007-008			5813-0023-000		
4'	4520-0007-009			SINGLE POLE		
5'	4520-0007-010			5813-11014-901		
6'	4520-0007-011					
8'	4520-0007-012					
10'	4520-0007-013					
TRANSFORMER		POWER RELAY				
120V	277V	24V	208/240V/277V			
5018-11003-000	5018-11003-002	410171001	410171003			
208/240V	347V	120V				
5018-11003-001	5018-11003-003	410171002				

THX FLOOR DROP-IN CONVECTOR							
ELEMENTS							
2 FOOT 188W/FT		2 FOOT 250W/FT		3 FOOT 188W/FT		3 FOOT 250W/FT	
208V	1802-2001-039	208V	1802-2001-198	208V	1802-2001-008	208V	1802-2001-009
240V	1802-2001-040	240V	1802-2001-099	240V	1802-2001-007	240V	1802-2001-008
277V	1802-2001-041	277V	1802-2001-200	277V	1802-2001-006	277V	1802-2001-007
4 FOOT 188W/FT		4 FOOT 250W/FT		5 FOOT 188W/FT		5 FOOT 250W/FT	
208V	1802-2001-014	208V	1802-2001-015	208V	1802-2001-020	208V	1802-2001-021
240V	1802-2001-013	240V	1802-2001-014	240V	1802-2001-019	240V	1802-2001-020
277V	1802-2001-012	277V	1802-2001-013	277V	1802-2001-018	277V	1802-2001-019

GRILLE							
2 FOOT FLUSH		2 FOOT SURFACE		3 FOOT FLUSH		3 FOOT SURFACE	
ALUMINUM	2501-11033-001	ALUMINUM	2501-11033-005	ALUMINUM	2501-11033-002	ALUMINUM	2501-11033-006
BLACK	2501-11033-101	BLACK	2501-11033-105	BLACK	2501-11033-102	BLACK	2501-11033-106
WHITE	2501-11033-201	WHITE	2501-11033-205	WHITE	2501-11033-202	WHITE	2501-11033-206
4 FOOT FLUSH		4 FOOT SURFACE		5 FOOT FLUSH		5 FOOT SURFACE	
ALUMINUM	2501-11033-003	ALUMINUM	2501-11033-007	ALUMINUM	2501-11033-004	ALUMINUM	2501-11033-008
BLACK	2501-11033-103	BLACK	2501-11033-107	BLACK	2501-11033-104	BLACK	2501-11033-108
WHITE	2501-11033-203	WHITE	2501-11033-207	WHITE	2501-11033-204	WHITE	2501-11033-208

TRANSFORMER	
277V	208/240V
5018-11003-002	5018-11003-001

TIME DELAY RELAY		
24V CONTROL	120V CONTROL	208-277V CONTROL
410171001	410171002	410171003

LINEAR LIMIT			
2 FOOT	3 FOOT	4 FOOT	5 FOOT
4520-0007-007	4520-0007-008	4520-0007-009	4520-0007-010

MANUAL RESET LIMIT			
2 FOOT	3 FOOT	4 FOOT	5 FOOT
4520-2017-000	4520-2017-000	4520-2017-001	4520-2017-001

POWER ON/OFF SW
ALL MODELS
410170001



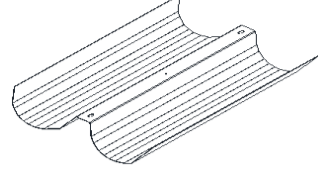
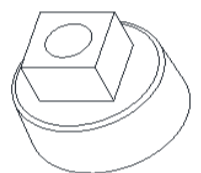
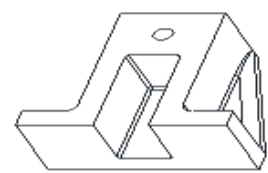
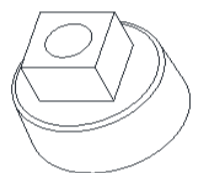
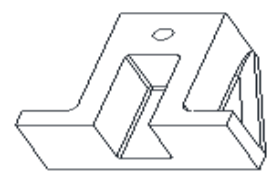
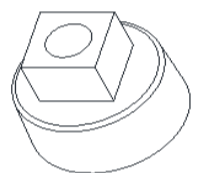
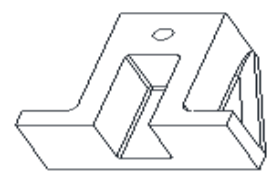
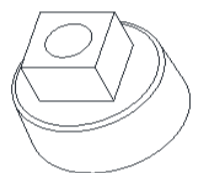
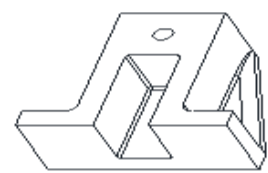

J-BOX COVER
ALL MODELS
1215-11125-000

MOUNTING LEG KIT ALL MODELS THX-ML-KIT

VRP/VRS SERIES RADIANT HEATERS

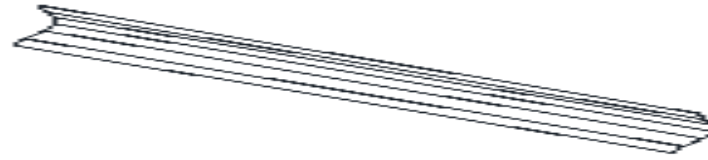
ELEMENTS					REFLECTOR			
								
PART NUMBER	TYPE	VOLTS	WATTS	USED WITH FIXTURE	5007-2003-000	5007-2003-001	5007-2003-002	
2MS08208	METAL SHEATH	208	850	RP22 RS22 RP32 RS32	RP223ASA	RP233ASA	RP243ASA	
2MS08240		240			RS223ASA	RS233ASA	RS243ASA	
2MS08277		277			5007-2010-000	RP223SA	RP233SA	RP243SA
2MS08347		347				RS223SA	RS233SA	RS243SA
2MS08480		480				5007-2011-000	RP226ASA	RP236ASA
2MS08600		600			RS226ASA		RS236ASA	RS246ASA
2QT10208	208	5007-2009-000	RP229SA		RP239SA		RP249SA	
2QT10240	240		RS229SA		RS239SA	RS249SA		
2QT10277	277		NA		NA	NA		
2QT10277	NA	NA	NA		NA	NA	NA	
2QL16208	QUARTS LAMP	208	1600		RP23 RS23 RP33 RS33	RP226ASA	RP236ASA	RP246ASA
2QL16240		240				RS226ASA	RS236ASA	RS246ASA
2QL16277		277		5007-2008-000		RP323ASA	RP333ASA	RP343ASA
2QL16347		347				RS323ASA	RS333ASA	RS343ASA
2QL16480		480				5007-2017-000	RP323SA	RP333SA
2QL16600		600		RS323SA			RS333SA	RS343SA
3MS15208	208	5007-2018-000	RP326ASA	RP336ASA			RP346ASA	
3MS15240	240		RS326ASA	RS336ASA		RS346ASA		
3MS15277	277		5007-2016-000	RP329SA		RP339SA	RP349SA	
3MS15347	347	RS329SA		RS339SA		RS349SA		
3MS15480	480	NA		NA		NA		
3MS15600	600	NA	NA	NA				
3QT15208	QUARTS TUBE	208	1500	RP24 RS24 RP34 RS34	RP326ASA	RP336ASA	RP346ASA	
3QT15240		240			RS326ASA	RS336ASA	RS346ASA	
3QT15277		277			5007-2016-000	RP329SA	RP339SA	RP349SA
3QT15347		347				RS329SA	RS339SA	RS349SA
3QT15480		480				NA	NA	NA
3QT15600		600			NA	NA	NA	
3QL25208	QUARTS LAMP	208	2500		ELEM TERM BUSH*  ALL MODELS 1213-0070-000	TERMINAL BLOCK*  ALL MODELS 1224-0049-000	NOTES * FOUR REQUIRED ON 2 ELEMENT AND SIX FOR 3 ELEMENT FIXTURES	
3QL25240		240						
3QL25277		277						
3QL25347		347						
3QL25480		480						
3QL25600		600						
4MS20208	METAL SHEATH	208	2000	ELEM TERM BUSH*  ALL MODELS 1213-0070-000		TERMINAL BLOCK*  ALL MODELS 1224-0049-000	NOTES * FOUR REQUIRED ON 2 ELEMENT AND SIX FOR 3 ELEMENT FIXTURES	
4MS20240		240						
4MS20277		277						
4MS20347		347						
4MS20480		480						
4MS20600		600						
4QT20208	QUARTS TUBE	208	2000		ELEM TERM BUSH*  ALL MODELS 1213-0070-000	TERMINAL BLOCK*  ALL MODELS 1224-0049-000	NOTES * FOUR REQUIRED ON 2 ELEMENT AND SIX FOR 3 ELEMENT FIXTURES	
4QT20240		240						
4QT20277		277						
4QT20347		347						
4QT20480		480						
4QT20600		600						
4QL36347	QUARTS LAMP	347	3650	ELEM TERM BUSH*  ALL MODELS 1213-0070-000		TERMINAL BLOCK*  ALL MODELS 1224-0049-000	NOTES * FOUR REQUIRED ON 2 ELEMENT AND SIX FOR 3 ELEMENT FIXTURES	
4QL36480		480						
4QL36600		600						

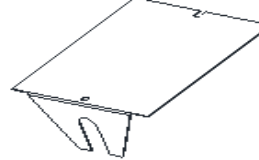

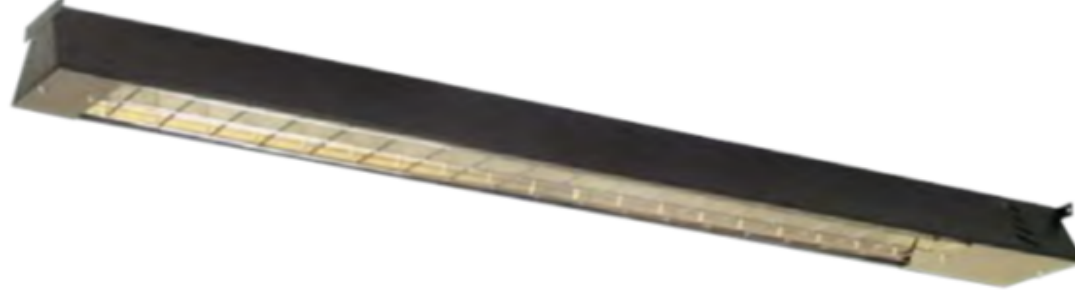
JRK SERIES			
ELEMENT		REFLECTOR	
			
1802-2113-501 RK41512A	1802-2113-515 RK53020A	5007-2013-000 RK41512A RK42020A RK42024A RK42027A RK42034A RK42048A RK42060A	5007-2013-001 RK53020A RK53024A RK53027A RK53034A RK53048A RK53060A
1802-2113-509 RK42020A	1802-2113-516 RK53024A		
1802-2113-510 RK42024A	1802-2113-517 RK53027A		
1802-2113-511 RK42027A	1802-2113-518 RK53034A		
1802-2113-512 RK42034A	1802-2113-519 RK53048A		
1802-2113-513 RK42048A	1802-2113-520 RK53060A		
1802-2113-514 RK42060A			
CHAIN 2 REQ.	"S" HOOK 4 REQ.		
			
1404-2000-001 ALL MODELS	2706-2000-000 ALL MODELS	1402-2275-000 ALL MODELS	1402-2275-001 ALL MODELS
			

RCC COVE HEATERS (C & D SERIES)

PARTS KIT*

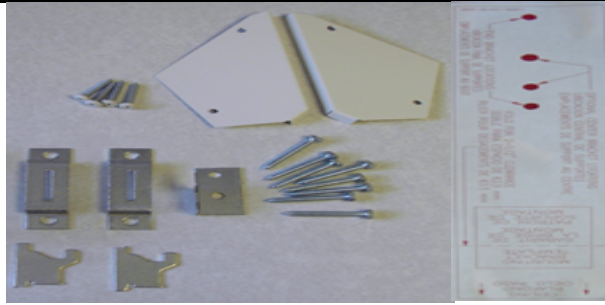

WHITE

3303-2032-000

CENTER SUP BRACKET**

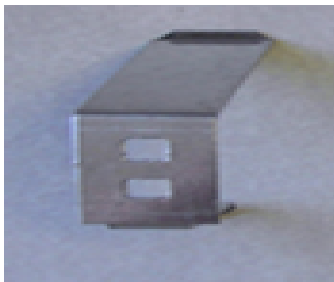

ALL MODELS
1215-2309-000

THERMOSTAT

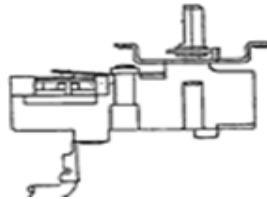

ALL MODELS
410129001

THERMOSTAT KNOB



ALL MODELS
3301-2020-006









NOTES

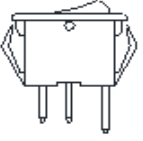
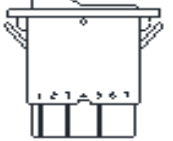
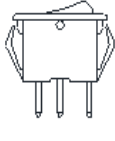
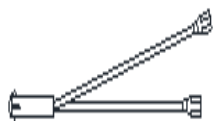
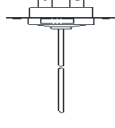
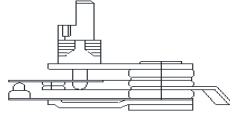
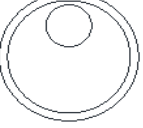

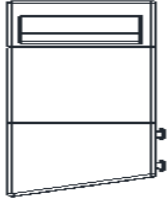
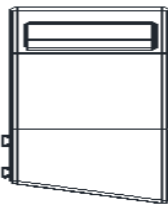

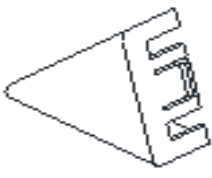

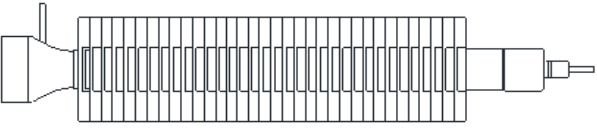

REPLACE HEATER IF FRONT COVER OR ELEMENT IS NEEDED

* PARTS KIT INCLUDES MOUNTING BRACKETS, MOUNTING TEMPLATE, AND END CAPS

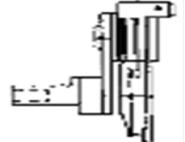

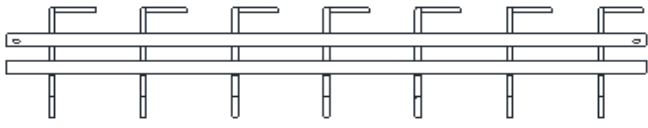
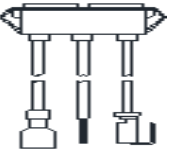

** 1500 & 1800 WATT MODELS TAKE TWO CENTER SUPPORT BRACKETS

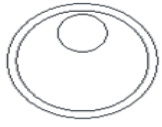
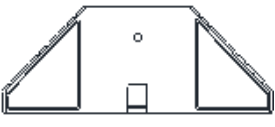
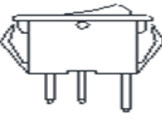
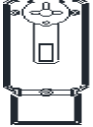



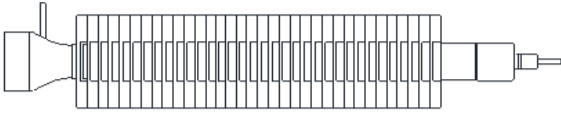
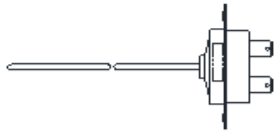
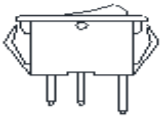
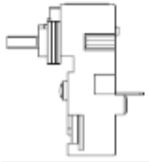
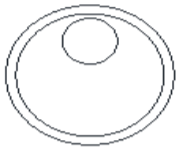

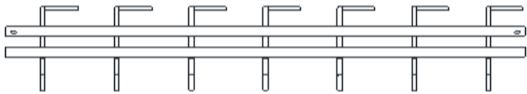
FBE SERIES					
ELEMENT		SWITCH			LIGHT
					
1802-2087-000 FBE15002C FBE15002CA		5216-2007-000 FBE1000A FBE1200 FBE1250A	5216-2010-000 FBE15002 FBE15002A	5216-11018-000 FBE15002B FBE15002C FBE15002CA	3510-2008-001 FBE1504C
LIMIT	THERMOSTAT	KNOB		FACE PLATE	
					
4520-2011-004 FBE1500C FBE15002A FBE15002B FBE15002C FBE15002CA	5813-2058-001 FBE1200 FBE1200C FBE1500C FBE15002B FBE15002C FBE15002CA FBE1504C	3301-2017-000 FBE1000A FBE1250A FBE15002 FBE15002A	3301-2011-003 FBE1200 FBE1200C FBE1500C FBE15002B FBE15002C FBE15002CA FBE1504C	1402-2122-139 FBE1000A	1402-2122-136 FBE15002
				1402-2122-141 FBE1200	1402-2122-138 FBE15002A
				1402-2122-125 FBE1200C	1402-2122-142 FBE15002B
				1402-2122-140 FBE1250A	1402-2122-626 FBE15002CA
END CAP RIGHT	END CAP LEFT	LEG RIGHT	LEG LEFT	CORD	CONTROL COVER
					
1800-2047-001 FBE1200C FBE1500C FBE15002C FBE15002CA FBE1504C	1800-2048-001 FBE1200C FBE1500C FBE15002C FBE15002CA FBE1504C	3507-2004-001 FBE1200C FBE1500C FBE15002C FBE15002CA FBE1504C	3507-2005-001 FBE1200C FBE1500C FBE15002C FBE15002CA FBE1504C	1420-2027-001 FBE15002C 1420-11013-000 FBE15002CA	1402-2243-001 FBE15002B FBE15002C FBE15002CA
					

LFP SERIES (OBSOLETE)					
ELEMENT		THERMOSTAT		LIMIT	
					
1802-2067-023 LFP6152D LFP6152E LFP6152EA	1802-2067-001 LFP675D	5813-2019-000 LFP6152 LFP6152D LFP6152E LFP6152EA	5813-2001-000 LFP675 LFP675D	410163004 LFP6152 LFP6152D LFP6152E LFP6152EA	4520-2010-001 LFP675 LFP675D
GRILLE	LIGHT	DIODE BRIDGE	FRONT COVER	CORD	
					
2501-2012-015 LFP6152 LFP6152D LFP6152E LFP6152EA	2501-2012-013 LFP675 LFP675D	3510-2006-000 LFP6152 LFP6152D LFP6152E LFP6152EA	DBKIT LFP6152 LFP6152D LFP6152E LFP6152EA	1402-2066-609 LFP6152EA	1420-11013-000 LFP6152D LFP6152E LFP6152EA
KNOB	LEG	SWITCH	END CAP		
					
3301-2011-001 LFP6152 LFP6152D LFP6152E LFP6152EA LFP675 LFP675D	3507-2003-000 LFP6152 LFP6152D LFP6152E LFP6152EA LFP675 LFP675D	5216-2007-000 LFP6152 LFP6152D LFP6152E LFP6152EA LFP675 LFP675D	1800-2027-000 LFP6152 LFP6152D LFP6152E LFP6152EA LFP675 LFP675D		





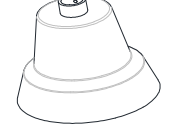
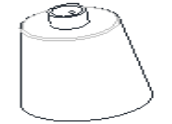

FHP SERIES

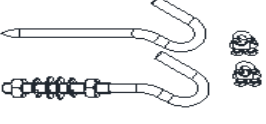

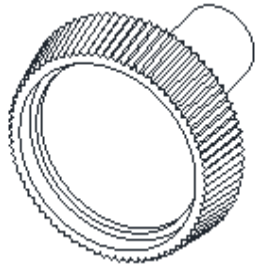
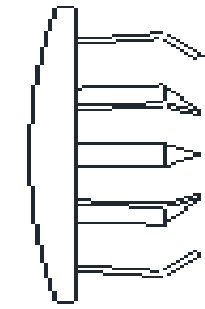
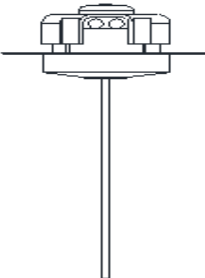
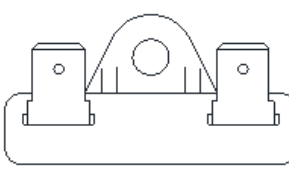
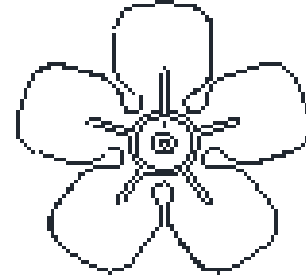

ELEMENT		LIMIT		SWITCH
				
1802-2067-001 FHP0750KCT FHP0750KCTA FHP0750T FHP0750TA	1802-2067-023 FHP1500KCT FHP1500KCTA FHP1500T FHP1500TA	4520-0011-000 FHP0750KCT FHP0750KCTA FHP0750T FHP0750TA	410163004 FHP1500KCT FHP1500KCTA FHP1500T FHP1500TA	5216-11020-000 FHP0750KCT FHP0750KCTA FHP0750T FHP0750TA FHP1500KCT FHP1500KCTA FHP1500T FHP1500TA
THERMOSTAT	KNOB	FRONT COVER		END CAP
				
5813-11012-000 FHP0750KCT FHP0750KCTA FHP0750T FHP0750TA FHP1500KCT FHP1500KCTA FHP1500T FHP1500TA	3301-2011-005 FHP0750KCT FHP0750KCTA FHP0750T FHP0750TA FHP1500KCT FHP1500KCTA FHP1500T FHP1500TA	1402-2066-607 FHP0750KCT FHP0750KCTA FHP0750T FHP0750TA	1402-2066-609 FHP1500KCT FHP1500KCTA FHP1500T FHP1500TA	1800-2027-000 FHP0750KCT FHP0750KCTA FHP0750T FHP0750TA FHP1500KCT FHP1500KCTA FHP1500T FHP1500TA
GRILLE		LEGS (2 REQ)	CORD	
				
2501-2012-013 FHP0750KCT FHP0750KCTA FHP0750T FHP0750TA	2501-2012-015 FHP1500KCT FHP1500KCTA FHP1500T FHP1500TA	3507-2003-000 FHP0750KCT FHP0750KCTA FHP0750T FHP0750TA FHP1500KCT FHP1500KCTA FHP1500T FHP1500TA	1420-11013-000 FHP0750KCT FHP0750KCTA FHP0750T FHP0750TA FHP1500KCT FHP1500KCTA FHP1500T FHP1500TA	

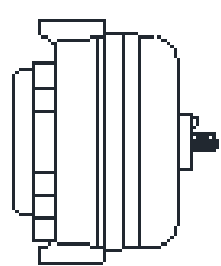
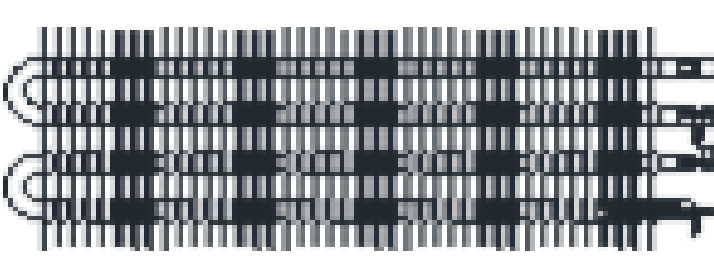
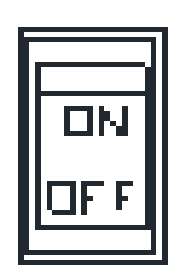

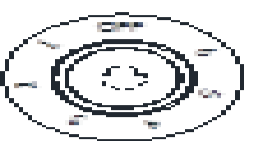

DOE INDUSTRIAL/COMMERCIAL CEILING FANS

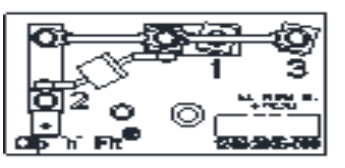
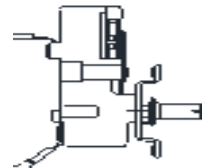
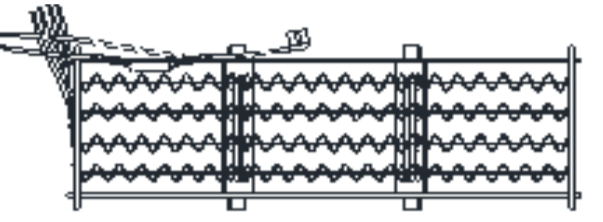
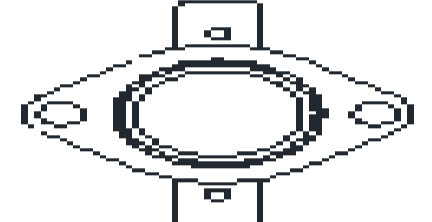
			ASSMBLY HAS SHACKLE AND RUBBER ROLLER					
MODEL	BLADES SET OF 3	MOTOR	DOWN ROD	SHACKLE	UPPER CANOPY	LOWER CANOPY	RUBBER ROLLER	SPEED CONTROL
56001HP	9B5600-1HP	9M5600-1HP	9D24BW	9F2900-03A	9F2900-07A	9F2900-08A	9F2900-04A	12003
56001HP-BRN	9B5600-1HPB		9D24BB	9F2900-03A	9FP029	9FP030	9F2900-04A	12003
56001HPDOE-K	9B5600-1HP	9M5600-1HP	9D24BW	9F2900-03A	9F2900-07A	9F2900-08A	9F2900-04A	12003
56001HPDOEBRN-K	9B5600-1HPB		9D24BB	9F2900-03A	9FP029	9FP030	9F2900-04A	12003
56001LCCDOE	9B5600-1LCC	9M5600-1LCC	9D24BW	9F2900-03A	9F2900-07A	9F2900-08A	9F2900-04A	CTL12004RSPDDOE
56001LCCDOE-K	9B5600-1LCC	9M5600-1LCC	9D24BW	9F2900-03A	9F2900-07A	9F2900-08A	9F2900-04A	CTL12004RSPDDOE
56201CLSDOE	9B56201CLS-1	9M56201CLS-1	9D16BW	9F2900-03A	9F2900-07A	9F2900-08A	9F2900-04A	CTL12004RSPDDOE
56201CLSDOE-K	9B56201CLS-1	9M56201CLS-1	9D16BW	9F2900-03A	9F2900-07A	9F2900-08A	9F2900-04A	CTL12004RSPDDOE
56007HPDOE	9B5600-7HP	9M5600-7HP	9D24BW	9F2900-03A	9F2900-07A	9F2900-08A	9F2900-04A	27708
56007HPDOE-K	9B5600-7HP	9M5600-7HP	9D24BW	9F2900-03A	9F2900-07A	9F2900-08A	9F2900-04A	27708
60001HPDOE	9B6000-1HP	9M6000-1HP	9D24BW	9F2900-03A	9F2900-07A	9F2900-08A	9F2900-04A	12003
60001PHDOE-BRN	9B6000-1HPB		9D24BB	9F2900-03A	9FP029	9FP030	9F2900-04A	12003
60001HPDOE-K	9B6000-1HP	9M6000-1HP	9D24BW	9F2900-03A	9F2900-07A	9F2900-08A	9F2900-04A	12003
60001HPDOEBRN-K	9B6000-1HPB		9D24BB	9F2900-03A	9FP029	9FP030	9F2900-04A	12003
36201DOE	9B3620-1C	9M3620-1C	9D24BB	9F2900-03A	9F2900-07A	9F2900-08A	9F2900-04A	CTL12004RSPDDOE
36201DOE-K	9B3620-1C	9M3620-1C	9D24BB	9F2900-03A	9F2900-07A	9F2900-08A	9F2900-04A	CTL12004RSPDDOE
48201DOE	9B48201-1C	9M48201-1C	9D24BB	9F2900-03A	9F2900-07A	9F2900-08A	9F2900-04A	CTL12004RSPDDOE
48201DOE-K	9B48201-1C	9M48201-1C	9D24BB	9F2900-03A	9F2900-07A	9F2900-08A	9F2900-04A	CTL12004RSPDDOE

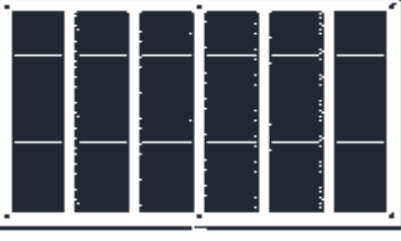

J HOOK KIT	MODELS ENDING IN K COME WITH SPEED CONTROL		
	VARIABLE SP. CONTROL	VOLTS	AMPS
	12003	120	3
	12006	120	6
	12008	120	8
9F2900-01	12012	120	12
ALL MODELS	27708	277	8
	NOISELESS SP. CONTROL		
	12001N	120	1
	12005N	120	5
	REVERSING SP. CONTROL		
	CTL12004RSPDDOE	120	4

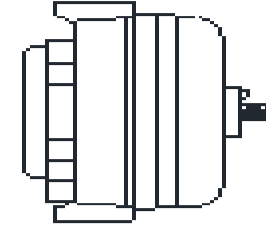
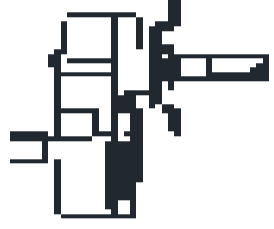
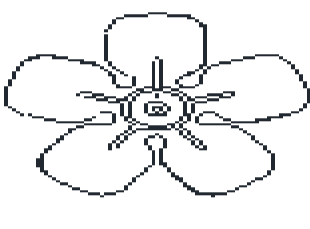
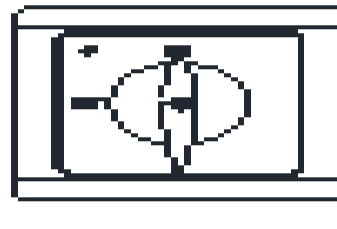
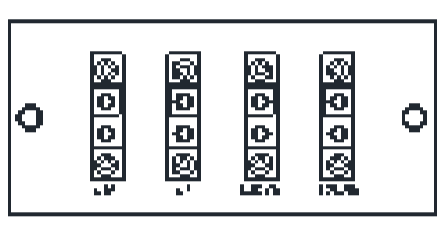
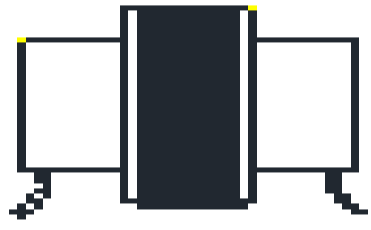
MCSSAR SERIES (OBSOLETE)					
KNOB	PLUG BUTTON	MANUAL RESET	THERMAL FUSE	FAN BLADE	THERMOSTAT
					
3301-11013-000 ALL MODELS	4506-2012-009 ALL MODELS	4520-11019-000 ALL MODELS	4520-2030-000 ALL MODELS	490030103 ALL MODELS	5813-2027-001 ALL MODELS
FAN DELAY			LIGHT		
					
1414-2039-000 MCARWH1802 MCARWH1802AL MCARWH1802BZ MCARWH1802W	410074000 MCARWH4804 MCARWH4804AL MCARWH4804BZ MCARWH4804W MCARWH4807 MCARWH4807AL		3510-2017-000 MCARWH1802 MCARWH1802AL MCARWH1802BZ MCARWH1802W	3510-2017-001 MCARWH4804 MCARWH4804AL MCARWH4804BZ MCARWH4804W MCARWH4807 MCARWH4807AL	
MOTOR			ELEMENT		DISCONNECT SWITCH
					
3900-2010-003 MCARWH1802 MCARWH1802AL MCARWH1802BZ MCARWH1802W	3900-2010-000 MCARWH4804 MCARWH4804AL MCARWH4804BZ MCARWH4804W MCARWH4808 MCARWH4808AL MCARWH4808BZ MCARWH4808W	3900-2010-001 MCARWH4807 MCARWH4807AL MCARWH4807BZ MCARWH4807W	302012828 MCARWH1802 MCARWH1802AL MCARWH1802BZ MCARWH1802W	302012810 MCARWH4804 MCARWH4804AL MCARWH4804BZ MCARWH4804W	410170001 ALL MODELS
			302012811 MCARWH4807 MCARWH4807AL MCARWH4807BZ MCARWH4807W	302012807 MCARWH4808 MCARWH4808AL MCARWH4808BZ MCARWH4808W	

QFG-SERIES (OBSOLETE)									
Knob	Grille	Blower ASM			Clip N Fit Board		Thermostat		
									
3301-2040-001 G1512T2M G2024T2M G1512T2MA G2024T2MA G2224T2MA G1512T2MB G2024T2MB G2224T2MB G1512T2MC G2024T2MC G2224T2MC	2501-2046-000 ALL MODELS	1225-2002-000 G1012IF G1512IF G1512M G1512T2M G1512IFMA G1512MA G1512T2MA G1512IFMB G1512MB G1512T2MB G1512IFMC G1512T2MC	1225-2002-001 G1024IF G1524IF G2024IF G2024M G2024T2M G2028IF G2224IF G2224M G2024IFMA G2024MA G2024T2MA G2028IFA G2224IFMA G2224MA	1225-2002-001 G2224T2MA G2024IFMB G2024MB G2024T2MB G2028IFB G2024IFMC G2024T2MC	1249-2005-000 G1512M G1512T2M G2024M G2024T2M G2224M G1512T2MA G2024IFMA G2024MA G2024T2MA G2224IFMA G2224MA G2224T2MA G1512IFMB	G1512MB G1512T2MB G2024IFMB G2024MB G2024T2MB G2224IFMB G2224T2MB G1512IFMC G1512T2MC G2024IFMC G2024T2MC G2224IFC G2224T2MC	410130001 G1512T2M G1512T2MA G1512T2MB G2024T2M G2024T2MA G2224T2MB G2024T2MC G2224T2MC		
Element		Hi Limit			Light				
									
1802-2124-005 G1024IF G2024IF	1802-2124-000 G1512IF G1512IFMA	4520-11012-000 G1512IFMC G1512T2MC	4520-11012-001 G2024IFMC G2024T2MC G2224IFC G2224T2MC G2228IFC	4520-2059-000 G1012IF G1512IF G1512M G1512T2M G1512IFMA G1512MA G1512T2MA G1512IFMB G1512MB G1512T2MB G1024IF G1524IF G2024IF G2024M G2024T2M G2228IFB	G2028IF G2224IF G2224M G2024IFMA G2024MA G2024T2MA G2028IFA G2224IFMA G2224MA G2224T2MA G2024IFMB G2024MB G2024T2MB G2028IFB G2224IFMB G2224T2MB G2228IFB G2024IFMC G2224IFC G2224T2MC G2224T2MC G2028IFA G2224IFMA G2224MA G2224T2MA	3510-2017-000 G1012IF G1512IF G1512M G1512T2M G1512IFMA G1512MA G1512T2MA G1512IFMB G1512MB G1512T2MB G1512IFMC G1512T2MC	3510-2017-001 G1024IF G1524IF G2024IF G2024M G2024T2M G2028IF G2224IF G2224M G2024IFMA G2024MA G2024T2MA G2028IFA G2224IFMA G2224MA G2224T2MA	G2024IFMB G2024MB G2024T2MB G2028IFB G2224IFMB G2224T2MB G2228IFB G2024IFMC G2224IFC G2224T2MC G2224T2MC G2228IFC	
1802-2125-000 G1512IFMB G1512MB G1512T2MB G1512IFMC G1512T2MC	1802-2125-002 G2024IFMB G2024MB G2024T2MB G2024IFMC G2024T2MC	 Patented Clip-N-Fit® feature (US Patented No. 6,172,343)		G1512MA G2024T2MA G2028IFA G2224IFMA G2224MA G2224T2MA G2024IF G2024IFMB G2024MB G2024T2MB G2024M G2024T2M G2228IFB	G1512T2MA G2024T2MA G2028IFA G2224IFMA G2224MA G2224T2MA G2024IF G2024IFMB G2024MB G2024T2MB G2024M G2028IFB G2224IFMB G2224T2MB	G1512T2MA G1512MA G1512T2MA G1512IFMB G1512MB G1512T2MB G1512IFMC G1512T2MC	G2024IFMB G2024MB G2024T2MB G2028IFB G2224IFMB G2224T2MB G2228IFB G2024IFMC G2224IFC G2224T2MC G2224T2MC G2028IFA G2224IFMA G2224MA G2224T2MA		
1802-2124-001 G2028IFB	1802-2125-001 G2224IFMB G2224T2MB					G2028IFB G2224IFC G2224T2MC	G2224IFC G2224T2MC	G2224IFC G2224T2MC	G2224IFC G2224T2MC
1802-2125-006 G2228IFB G2228IFC	G2224IFC G2224T2MC					G2228IFB G2228IFC	G2228IFB G2228IFC	G2228IFB G2228IFC	G2228IFB G2228IFC
MODELS NOT LISTED ELEMENTS ARE OBSOLETE									

MFQ-SERIES (OBSOLETE)					
GRILLE	ELEMENTS (2 REQ)			MOTOR (2 REQ)	
					
2501-2027-000 ALL MODELS	302012819 Q6003	302012821 Q8003	302012809 Q6004 Q8007	3900-2010-000 Q6003 Q6004 Q60048 Q6006 Q6008 Q8003 Q8004 Q80048 Q8006 Q8008	3900-2010-001 Q6007 Q8007
	302012820 Q6006 Q8006	302012826 Q80048	302012806 Q6007		
	302012825 Q60048	302012808 Q6008 Q8004	302012807 Q8008		
THERMOSTAT	FAN BLADE (2 REQ)	DISCONNECT SW.	TERMINAL BOARD		
					
410168002 (2REQ.) Q6003 Q60048 Q6006 Q8003 Q80048 Q8006	5813-0023-000 Q6004 Q6007 Q6008 Q8004 Q8007 Q8008	490030103 ALL MODELS	5216-2025-000 ALL MODELS	5823-2002-000 ALL MODELS	
TRANSFORMER			FAN DELAY (2 REQ)	MANUAL LIMIT (2 REQ)	
					
490015017 Q6003 Q8003	490015022 Q60048 Q80048	490015013 Q6006 Q8006	410074000 ALL MODELS	4520-2027-000 ALL MODELS	

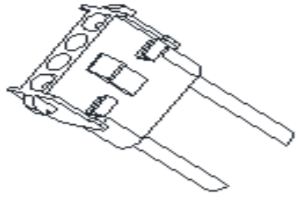
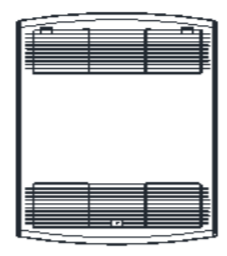
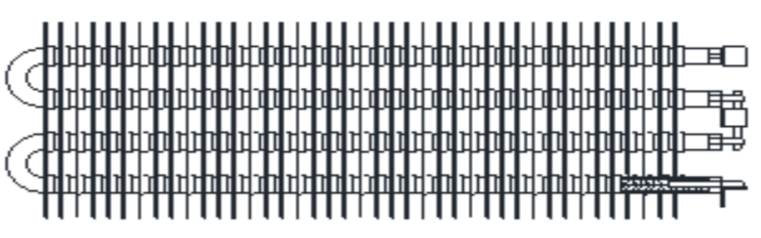
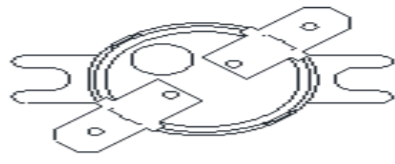

ECP SERIES (OBSOLETE)				
PLUG ASSY FEMALE	GRILLE	ELEMENT		LIMIT
				
1016-0114-000 ALL MODELS	2501-2082-000 ALL MODELS	302012808 ECP1024	302012803 ECP1524	4520-2025-001 ALL MODELS
				

MFA SERIES (OBS)

ELEMENTS

LIMIT

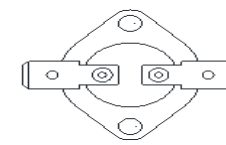

1802-2021-000

A1000IF
A1000IFA
A1000IFB
A1000IFBNW
A1000T
A1000TA
A1000T2
A1000T2B
A1000T2BNW

A1500IF
A1500IFA
A1500IFB
A1500IFBNW
A1500T
A1500TA
A1500T2
A1500T2B
A1500T2BNW

1802-2021-003

A1504IF
A1504IFA
A1504IFB
A1504IFBNW
A1504T
A1504TA
A1504T2
A1504T2B
A1504T2BNW

1802-2021-004

A1004IF
A1004IFA
A1004IFB
A1004IFBNW
A2004IF
A2004IFA
A2004IFB
A2004IFBNW
A2004T
A2004TA
A2004T2
A2004T2B
A2004T2BNW

A2004T2B
A2004T2BNW
A2404IF
A2404IFA
A2404IFB
A2404IFBNW
A2404TA
A2404T2
A2404T2B
A2404T2BNW

4520-2023-000

A1000IF
A1000IFB
A1000IFBNW
A1000T
A1000T2B
A1000T2BNW
A1004IF
A1004IFB
A1004IFBNW
A1500IF
A1500IFB

A1500IFBNW
A1500T
A1500T2B
A1500T2BNW
A1504IF
A1504IFB
A1504IFBNW
A1504T
A1504T2B
A1504T2BNW
A2004IF

A2004IFB
A2004IFBNW
A2004T
A2004T2B
A2004T2BNW
A2404IF
A2404IFB
A2404IFBNW
A2404TA
A2404T2
A2404T2B
A2404T2BNW

MOTOR

THERMOSTAT

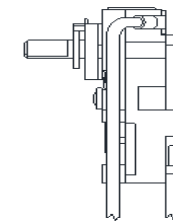
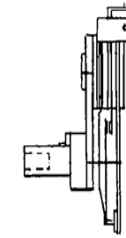
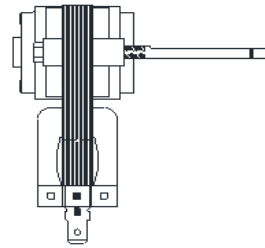

3900-2017-000

A0500IFA
A0500IFB
A0500IFBNW
A0750IFA
A0750IFB
A0750IFBNW
A1000IF
A1000IFA
A1000IFB
A1000IFBNW
A1000T
A1000TA
A1000T2
A1000T2B
A1000T2BNW

A1000T2
A1000T2B
A1000T2BNW
A1500IF
A1500IFA
A1500IFB
A1500IFBNW
A1500T
A1500TA
A1500T2
A1500T2B
A1500T2BNW

3900-2017-001

A0504IFA
A0504IFB
A0504IFBNW
A0504TA
A0504T2
A0504T2B
A0504T2BNW
A0754IFA
A0754IFB
A0754IFBNW
A1004IF
A1004IFA
A1004IFB
A1004IFBNW

A1504IF
A1504IFA
A1504IFB
A1504IFBNW
A1504T
A1504TA
A1504T2
A1504T2B
A1504T2BNW
A2004IF
A2004IFA
A2004IFB
A2004IFBNW
A2004T

A2004TA
A2004T2
A2004T2B
A2004T2BNW
A2404IF
A2404IFA
A2404IFB
A2404IFBNW
A2404TA
A2404T2
A2404T2B
A2404T2BNW





5813-2001-000

A0504TA
A1000T
A1000TA
A1500T
A1500TA
A1504TA
A1504T2
A2004T
A2004TA
A2404T
A2404TA

5813-2015-000

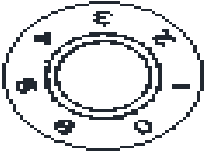
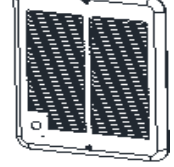
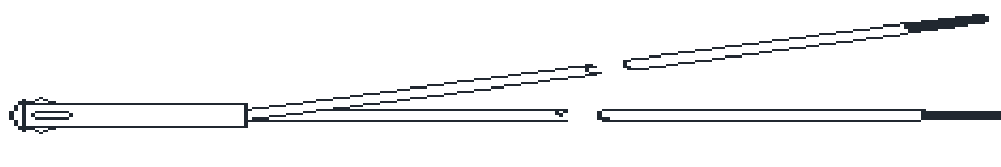
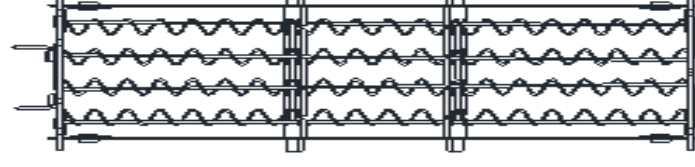
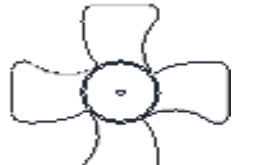
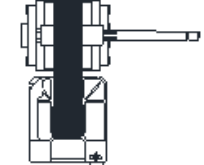
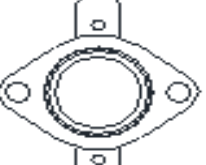

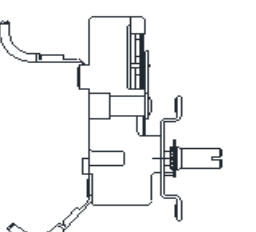
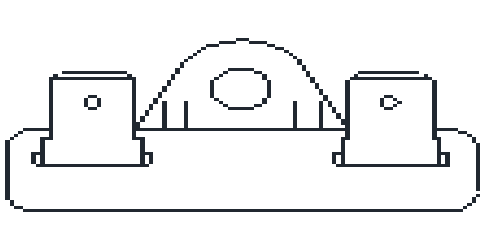
A0504T2
A0504T2B
A0504T2BNW
A1000T2
A1000T2B
A1000T2BNW
A1500T2
A1500T2B



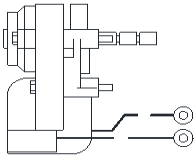
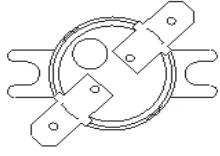

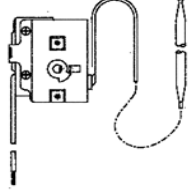
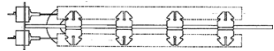
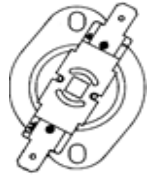
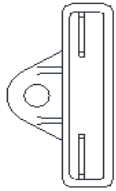
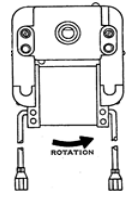

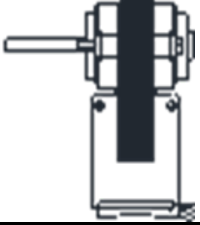
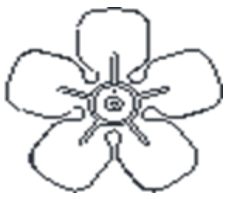
A1500T2BNW
A1504T2B
A1504T2BNW
A2004T2
A2004T2B
A2004T2BNW
A2404T2B
A2404T2BNW

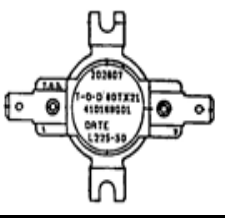

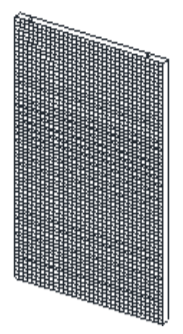
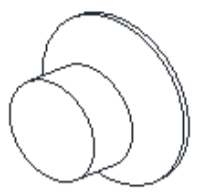
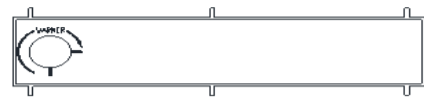
CRA SERIES									
KNOB	GRILLE	LIGHT					ELEMENT		
									
3301-2039-002 C1012T2 C1012T2AA C1024T2 C1512T2AA C1512T2 C1012T2AB C1524T2 C1024T2AB C2024T2 C1512T2AB C2028T2 C1524T2AB C2224T2 C2024T2AB C1012T2A C2224T2AB C1024T2A C1512T2B C1512T2A C2024T2B C1524T2A C2224T2B C2024T2A C1512T2C C2028T2A C2024T2C C2224T2A C2224T2C	2501-2065-000 C1512IFB C1512T2B C2024IFB C2024T2B C2028IFB C2224IFB C2224T2B C1512IFC C1512T2C C2024IFC C2024T2C C2028IFC C2224IFC C2224T2C	3510-2017-000 C1012IF C1012T2 C1512IF C1512T2 C1512T2 C1012IFA C1012T2A C1512IFA C1512T2A C1012IFAA C1012T2AA C1512IFAA C1024T2A C1524IFA C1524T2A C2224IFAB C2028T2A C2224IFAB C2028T2A C2224IFB C2224T2C C2028IFC C2224T2C	3510-2017-001 C1024IF C1024T2 C1524IF C1524T2 C2024IF C2024T2 C2028IF C2028T2 C2224IF C2224T2 C1024IFA C1024T2A C1524IFA C1524T2A C1524T2A C2024IFA C2024IFA C2024T2A C2028IFA C2028T2A C2224IFA C2224T2A	3510-2017-002 C1512IFAB C1512T2AB C1512IFB C1512T2B C1512IFC C1512T2C	3510-2017-003 C1024IFAB C1024T2AB C1524IFAB C1524T2AB C2024IFAB C2024T2AB C2028IFAB C2028T2AB C2224IFAB C2224T2AB C2024IFB C2024T2B C2028IFB C2028T2B C2224IFB C2224T2B C2024IFC C2024T2C C2028IFC C2028T2C C2224IFC C2224T2C	1802-2124-005 C1024IF C1024T2 C2024IF C2024T2 C1024IFA C1024T2A C2024IFA C2024T2A C2024T2A	1802-2124-000 C1512IF C1512T2 C1512IFA C1512T2A 1802-2124-002 C2224IFA C2224T2A 1802-2127-005 C2024IFB C2024T2B C2024IFC C2024T2C	1802-2124-003 C1012IFA C1012T2A 1802-2124-001 C2028IFA C2028T2A 1802-2127-000 C1512IFB C1512T2B C1512IFC C1512T2C 1802-2127-001 C2028IFB C2028T2A C2028IFC C2028T2A	
MODELS NOT LISTED ARE OBSOLETE									
FAN BLADE	MOTOR			HI LIMIT			CLIP N FIT BOARD		
									
1210-2008-000 ALL MODELS	3900-2017-000 C1012IF C1012T2 C1512IF C1512T2 C1012IFA C1012T2A C1512IFA C1512T2A C1012IFAA C1012T2AA C1512IFAA C1512T2AA C1012IFAB C1012T2AB C1512IFAB C1512T2AB C1512IFB C1512T2B C1512IFC C1512T2C	3900-2017-001 C1024IF C1024T2 C1524IF C1524T2 C2024IF C2024T2 C1024IFA C1024T2A C1524IFA C1524T2A C2024IFA C2024T2A C1024IFAB C1024T2AB C1524IFAB C1524T2AB C2024IFAB C2024T2AB C2024IFB C2024T2B C2024IFC C2024T2C	3900-2035-000 C2028IF C2028T2 C2224IF C2224T2 C2028IFA C2028T2A C2224IFA C2224T2A C2028IFAB C2028T2AB C2224IFAB C2224T2AB C2028IFB C2028T2B C2224IFB C2224T2B C2028IFC C2028T2C	4520-11007-000 C1512IFC C1512T2C	4520-11007-001 C2024IFC C2024T2C C2028IFC C2224IFC C2224T2C	C1012IF C1012T2 C1512IF C1512T2 C1012IFA C1012T2A C1512IFA C1512T2A C1012IFAA C1012T2AA C1512IFAA C1512T2AA C1012IFAB C1012T2AB C1512IFAB C1512T2AB C1512IFB C1512T2B C1512IFC C1024IF C1024T2 C1524IF C1524T2 C1524T2A	4520-2059-000 C2024IF C2024T2 C1024IFA C1024T2A C1524IFA C1524T2A C2024IFA C2024T2A C1024IFAB C1024T2AB C1524IFAB C1524T2AB C2024IFAB C2024T2AB C2024IFB C2024T2B C2028IF C2028T2 C2224IF C2224T2 C2028IFA C2028T2A	1249-2005-000 C1512IFB C1512T2B C2024IFB C2024T2B C2028IFB C2224IFB C2224T2B C1512IFC C1512T2C C2024IFC C2024T2C C2028IFC C2224IFC C2224T2C	
THERMOSTAT	THERMAL FUSE								
									
410130001 C1012T2 C1512T2 C1012T2A C1512T2A C1012T2AA C1512T2AA C1024T2 C1524T2 C2024T2 C1024T2A C1524T2A C2224T2B C2028T2 C2224T2 C2028T2A C2224T2A	5813-2090-000 C1012T2AB C1512T2AB C1512T2B C1512T2C C1024T2AB C1524T2AB C2024T2AB C2024T2B C2024T2C C2224T2AB C2224T2B C2224T2C	4520-2030-000 C1012IFAA C1512IFB C1012T2AA C1512T2B C1512IFAA C2024IFB C1512T2AA C2024T2B C1012IFAB C2028IFB C1012T2AB C2224IFB C1512IFAB C2224T2B C1512T2AB C1512IFC C1024IFAB C1512T2C C1024T2AB C2024IFC C1524IFAB C2024T2C C1524T2AB C2028IFC C2024IFAB C2224IFC C2024T2AB C2224T2C C2024IFB C2024T2B C2028IFAB C2028T2A C2224IFAB C2224T2A							
									

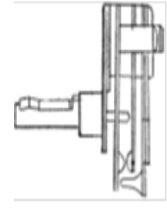
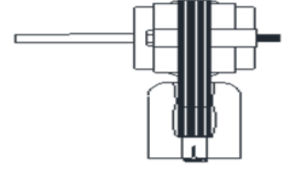
BVP					
MOTOR			LIMIT		
					
42528-052-01		42528-052-02		4520-2025-000	
VP1222	VP1222I	VP2022	VP2022I	VP1222C	VP2022IC
VP1222A	VP1222IB	VP2022A	VP2022IB	VP1222CNW	VP2022ICNW
VP1222AI	VP1222IBP	VP2022AI	VP2022IBP	VP1222IC	VP2422C
VP1222B	VP1222IC	VP2022B	VP2022IC	VP1222ICNW	VP2422CNW
VP1222C	VP1222ICNW	VP2022C	VP2022ICNW	VP2022C	VP2422IC
VP1222CNW		VP2022CNW		VP2022CNW	VP2422ICNW

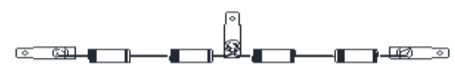
A2500					
THERMOSTAT	ELEMENT	LIMIT	THERMAL FUSE	GRILLE	MOTOR
				PICTURE NOT AVAILABLE	
1230-8232	6101-8752	8541-8056	8671-8037	8683-8272	8767-8036
A2515T	A2530T	A2515T	A2515T	A2515T	A2515T
A2520T		A2520T	A2520T	A2520T	A2520T
A2530T		A2530T	A2530T	A2530T	A2530T
A2540T		A2540T	A2540T	A2540T	A2540T
A2548T		A2548T	A2548T	A2548T	A2548T

SCH SERIES						
ELEMENT						
						
302023801	302023802	302023803	302023804	302023805	302023806	302023807
SCH1012IF	SCH1512IF	SCH1527IF	SCH2020IF	SCH2024IF	SCH2027IF	SCH2012IF
SCH1012W	SCH1512W	SCH1527W	SCH2020W	SCH2024W	SCH2027W	SCH2012W
MOTOR				BLADE	FAN DELAY	LIMIT
						
490062001	490062002	490062003	490062004	490061001	410074000	410169001
SCH1012IF	SCH2020IF	SCH2024IF	SCH1527IF	ALL MODELS	ALL MODELS	ALL MODELS
SCH1012W	SCH2020W	SCH2024W	SCH1527W			
SCH1512IF			SCH2027IF			
SCH1512W			SCH2027W			
SCH2012IF						
SCH2012W						

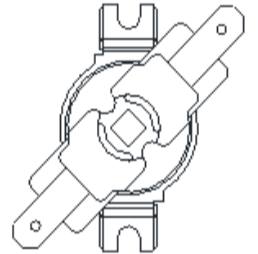
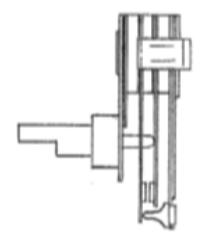
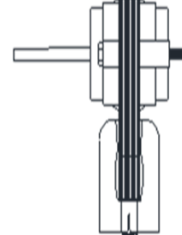
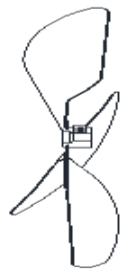
1235 & 2435 SERIES (OBS)					
SCREEN		KNOB	FACE PLATE	LIMIT	
					
1235-0037 1235 2435	8850-8046 1235P 2435P	3301-2047-000 ALL MODELS	4503-2094-000 ALL MODELS	8541-8054 ALL MODELS	
THERMOSTAT	MOTOR	FAN BLADE	ELEMENT	THERMAL FUSE	
					
1230-8194 ALL MODELS	1235-0007 ALL MODELS	1235-0008 ALL MODELS	6101-8741 ALL MODELS	8671-8036 2435 2435P	





B2400 SERIES (OBS)			
ELEMENT		LIMIT	THERMOSTAT
			
6101-8741 B2451	6101-8742 B2452	8541-8055 ALL MODELS	1230-8206 ALL MODELS
MOTOR		FAN BLADE	THERMAL FUSE
			
8767-8035 B2451	8767-8036 B2452	991-313 ALL MODELS	8671-8037 B2452

SR SERIES (OBSOLETE)



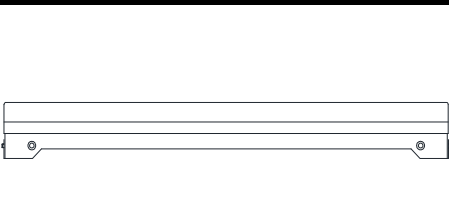
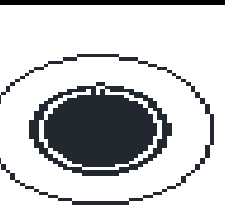
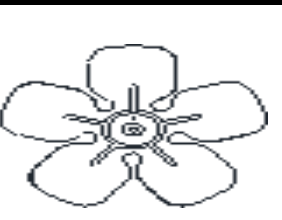
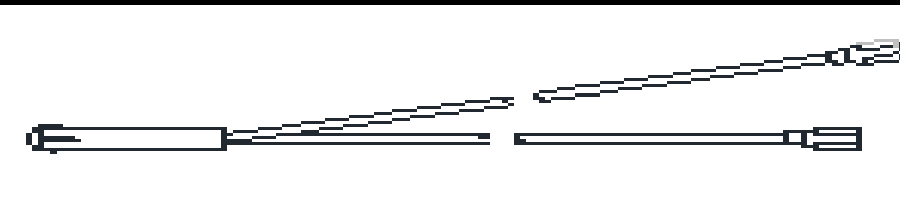
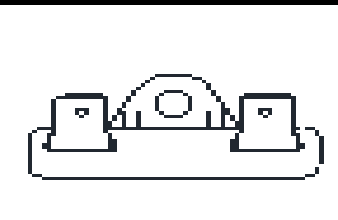
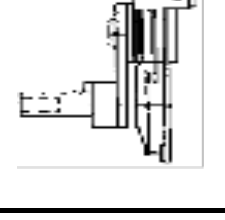
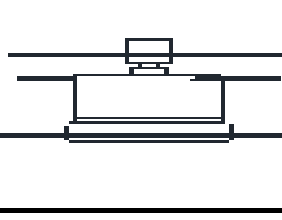
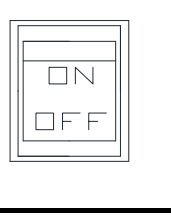

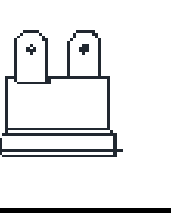
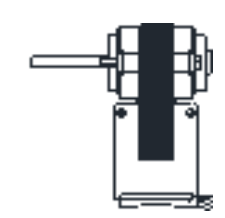
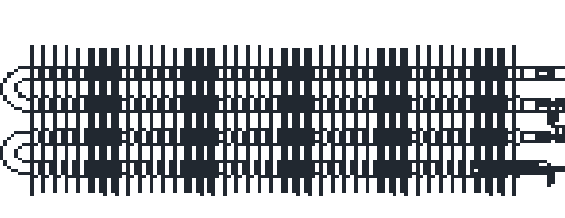
ELEMENT





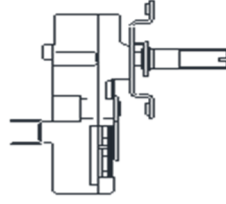
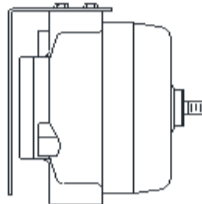
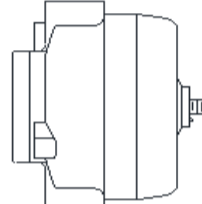





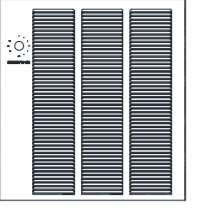



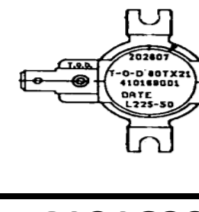
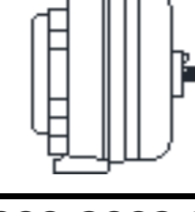

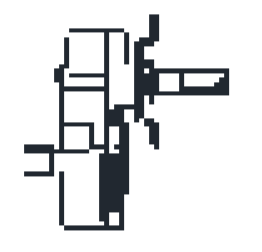
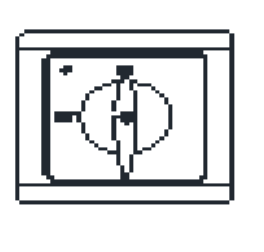
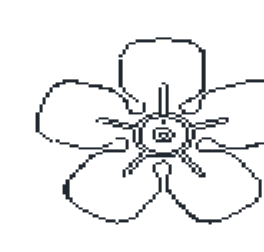
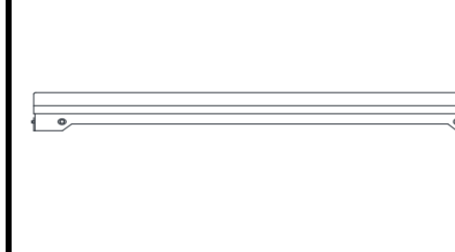
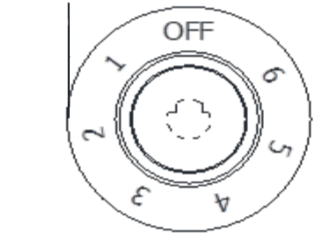



<p>302023801 SR1012IFLTC SR1012IFLTP SR1012IFLTPB SR1012IFP SR1012LTC SR1012LTP SR1012LTPB SR1012P</p>							<p>302023802 SR1512CKJCP SR1512IFLTC SR1512IFLTP SR1512IFLTPB SR1512IFP SR1512LTC SR1512LTP SR1512LTPB SR1512P</p>		<p>302023803 SR1527IFLTC SR1527IFLTP SR1527IFLTPB SR1527IFP SR1527LTC SR1527LTP SR1527LTPB SR1527P</p>		<p>302023804 SR2020IFLTC SR2020IFLTP SR2020IFLTPB SR2020IFP SR2020LTC SR2020LTP SR2020LTPB SR2020P</p>		<p>302023805 SR2024IFLTC SR2024IFLTP SR2024IFLTPB SR2024IFP SR2024LTC SR2024LTP SR2024LTPB SR2024P</p>		<p>302023806 SR2027IFLTC SR2027IFLTP SR2027IFLTPB SR2027IFP SR2027LTC SR2027LTP SR2027LTPB SR2027P</p>		<p>302023807 SR2012IFLTC SR2012IFLTP SR2012IFLTPB SR2012IFP SR2012LTC SR2012LTP SR2012LTPB SR2012P</p>
KNOB			THERMOSTAT				FAN DELAY										
<p>3301-2020-008</p> <p>SR1012C SR1012IFC SR1012IFP SR1012IFPB SR1012P SR1012PB SR1512C SR1512CKJCP SR1512IFC SR1512IFP SR1512IFPB SR1512P SR1512PB SR1527C SR1527IFC</p>			<p>SR1527IFP SR1527IFPB SR1527P SR1527PB SR2012C SR2012IFC SR2012IFP SR2012IFPB SR2012P SR2012PB SR2020C SR2020IFC SR2020IFP SR2020IFPB SR2020P</p>		<p>SR2020PB SR2024C SR2024IFC SR2024IFP SR2024IFPB SR2024P SR2024PB SR2027C SR2027IFC SR2027IFP SR2027IFPB SR2027P SR2027PB</p>		<p>5813-2027-000</p> <p>SR1012C SR1012IFC SR1012IFP SR1012IFPB SR1012P SR1012PB SR1512C SR1512CKJCP SR1512IFC SR1512IFP SR1512IFPB SR1512P SR1512PB SR1527C SR1527IFC</p>		<p>SR1527IFP SR1527IFPB SR1527P SR1527PB SR2012C SR2012IFC SR2012IFP SR2012IFPB SR2012P SR2012PB SR2020C SR2020IFC SR2020IFP SR2020IFPB SR2020P</p>		<p>410074000 ALL MODELS</p>						
BLADE			MOTOR														
<p>490061001</p> <p>SR1012IFLTC SR1012IFLTP SR1012IFLTPB SR1012IFP SR1012LTC SR1012LTP SR1012LTPB SR1012P SR1512CKJCP SR1512IFLTC SR1512IFLTP SR1512IFLTPB SR1512IFP SR1512LTC SR1512LTP SR1512LTPB SR1512P SR1527IFLTC SR1527IFLTP SR1527IFLTPB SR1527IFP SR1527LTC</p>			<p>SR1527LTP SR1527LTPB SR1527P SR2012IFLTC SR2012IFLTP SR2012IFLTPB SR2012IFP SR2012LTC SR2012LTP SR2012LTPB SR2012P SR2012PB SR2020IFLTC SR2020IFLTP SR2020IFLTPB SR2020IFP SR2020LTC SR2020LTP SR2020LTPB SR2020P SR2024IFLTC SR2024IFLTP SR2024IFLTPB</p>		<p>SR2024IFP SR2024LTC SR2024LTP SR2024LTPB SR2024P SR2027IFLTC SR2027IFLTP SR2027IFLTPB SR2027IFP SR2027LTC SR2027LTP SR2027LTPB SR2027P</p>		<p>490062001</p> <p>SR1012IFLTC SR1012IFLTP SR1012IFLTPB SR1012IFP SR1012LTC SR1012LTP SR1012LTPB SR1012P SR1512CKJCP SR1512IFLTC SR1512IFLTP SR1512IFLTPB SR1512IFP</p>		<p>SR1512LTC SR1512LTP SR1512LTPB SR1512P SR2012IFLTC SR2012IFLTP SR2012IFLTPB SR2012IFP SR2012LTC SR2012LTP SR2012LTPB SR2012P</p>		<p>490062002</p> <p>SR2020IFLTC SR2020IFLTP SR2020IFLTPB SR2020IFP SR2020LTC SR2020LTP SR2020LTPB SR2020P</p>		<p>490062003</p> <p>SR2024IFLTC SR2024IFLTP SR2024IFLTPB SR2024IFP SR2024LTC SR2024LTP SR2024LTPB SR2024P</p>		<p>490062004</p> <p>SR1527IFLTC SR1527IFLTP SR1527IFLTPB SR1527IFP SR1527LTC SR1527LTP SR1527LTPB SR1527P SR2027IFLTC SR2027IFLTP SR2027IFLTPB SR2027IFP SR2027LTC SR2027LTP SR2027LTPB SR2027P</p>		





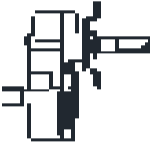

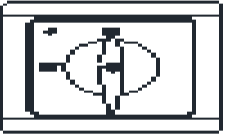

SRA SERIES WALL HEATER (OBS)								
GRILLE	PLASTIC COVER(2REQ)	KNOB	FAN BLADE	LIGHT				THERMAL FUSE
								
1402-2117-001 ALL MODELS	1402-2119-000 ALL MODELS	3301-2014-001 ALL MODELS	490061001 ALL MODELS	3510-2008-003 SRA1012B SRA1512B SRA1812B SRA1012DSB SRA1512DSB SRA1812DSB	3510-2008-002 SRA1527B SRA2020B SRA2024B SRA2027B SRA1527DSB SRA2020DSB SRA2024DSB SRA2027DSB	3510-2008-006 SRA1012DSC SRA1512DSC SRA1812DSC	3510-2008-007 SRA1527DSC SRA2020DSC SRA2024DSC SRA2027DSC	4520-2030-000 SRA1012DSC SRA1512DSC SRA1527DSC SRA1812DSC SRA2020DSC SRA2024DSC SRA2027DSC
THERMOSTAT		MANUAL LIMIT	DISCONNECT SW.	FAN DELAY			HI LIMIT	
								
5813-2001-000 SRA1012 SRA1012IF SRA1012A SRA1012B SRA1012DS SRA1012DSB SRA1012DSC SRA1512 SRA1512IF SRA1512A SRA1512B SRA1512DS SRA1512DSB SRA1512DSC SRA1527 SRA1527IF SRA1527A SRA1527B SRA1527DSB SRA1527DSC		5813-2022-000 SRA1812 SRA1812IF SRA1812A SRA1812B SRA1812DSB	4520-11016-000 SRA1012A SRA1512A SRA1527A SRA1812A SRA2020A SRA2024A SRA2027A SRA1012DS SRA1512DS SRA2024DS SRA2027DS SRA1012DSC SRA1512DSC SRA2024DSC SRA2027DSC SRA1812DSC SRA2020DSC SRA2024DSC SRA2027DSC SRA1527DSC SRA2020DSC SRA2024DSC SRA2027DSC	410170001 SRA1012DS SRA1012DSB SRA1012DSC SRA1512DS SRA1512DSB SRA1512DSC SRA1527DSC SRA1812DSB SRA1812DSC SRA2020DSB SRA2024DS SRA2024DSB SRA2024DSC SRA2027DS SRA2027DSB SRA2027DSC	410074000 SRA1012 SRA1012IF SRA1012B SRA1012DSB SRA1512 SRA1512IF SRA1512B SRA1512DSC SRA1527 SRA1527IF SRA1527B SRA1527DSB SRA1527DSC SRA1812 SRA1812IF	SRA1812B SRA1812DSB SRA1812DSC SRA2020 SRA2020IF SRA2020B SRA2020DSB SRA2020DSC SRA2024 SRA2024IF SRA2024B SRA2024DSB SRA2027 SRA2027B SRA2027DSB SRA2027DSC	410143000 SRA1012 SRA1512 SRA1527 SRA1812 SRA2020 SRA2024 SRA2027 SRA1012IF SRA1512IF SRA1527IF SRA1812IF SRA2020IF SRA2024IF	SRA1012B SRA1512B SRA1527B SRA1812B SRA2020B SRA2024B SRA2027B SRA1012DSB SRA1512DSB SRA1527DSB SRA1812DSB SRA2020DSB SRA2024DSB SRA2027DSB
MOTOR				ELEMENT				
								
490062001 SRA1012 SRA1512 SRA1812 SRA1012IF SRA1512IF SRA1812IF SRA1012A SRA1512A SRA1812A SRA1012B SRA1512B SRA1812B SRA1012DS SRA1512DS SRA1012DSB SRA1512DSB SRA1812DSB SRA1012DSC SRA1512DSC SRA1812DSC	490062002 SRA2020 SRA2020IF SRA2020A SRA2020B SRA2020DSB SRA2020DSC	490062003 SRA2024 SRA2024IF SRA2024A SRA2024B SRA2024DS SRA2024DSB SRA2024DSC	490062004 SRA1527 SRA2027 SRA1527IF SRA1527A SRA2027A SRA1527B SRA2027B SRA2027DS SRA1527DSB SRA2027DSB SRA1527DSC SRA2027DSC	302023801 SRA1012 SRA1012IF SRA1012A SRA1012B SRA1012DS SRA1012DSB SRA1012DSC 302023802 SRA1512 SRA1512IF SRA1512A SRA1512B SRA1512DS SRA1512DSB SRA1512DSC	302023803 SRA1527 SRA1527IF SRA1527A SRA1527B SRA1527DSB SRA1527DSC 302023808 SRA1812 SRA1812IF SRA1812A SRA1812B SRA1812DSB SRA1812DSC 302023806 SRA2027 SRA2027A SRA2027B SRA2027DS SRA2027DSB SRA2027DSC	302023804 SRA2020 SRA2020IF SRA2020A SRA2020B SRA2020DSB SRA2020DSC 302023805 SRA2024 SRA2024IF SRA2024A SRA2024B SRA2024DS SRA2024DSB SRA2024DSC		

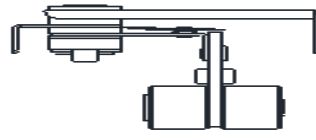
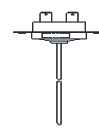
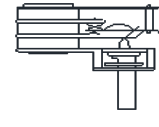
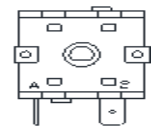



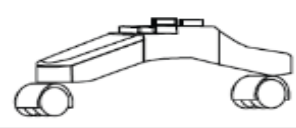

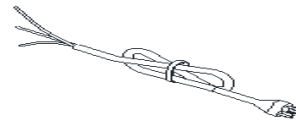



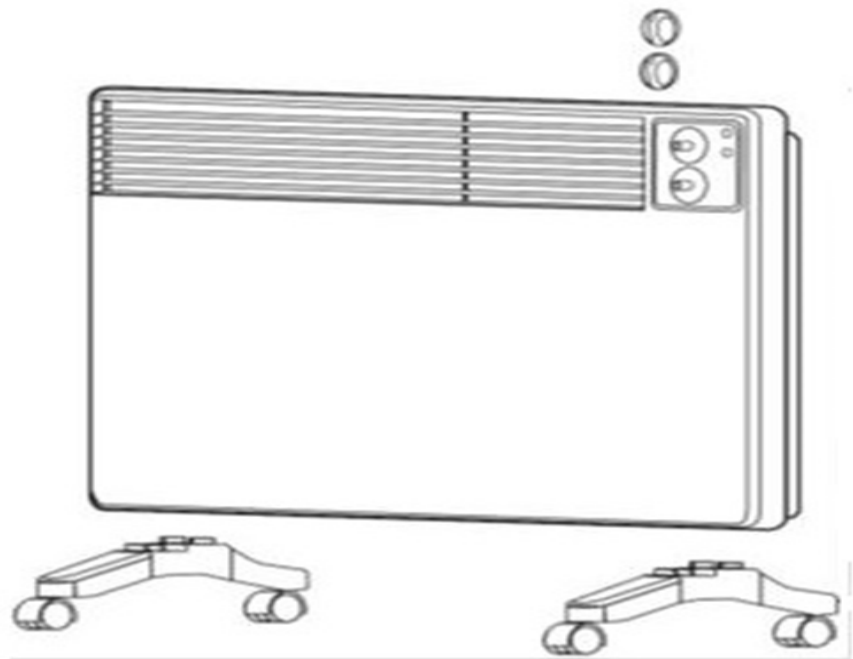

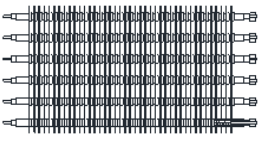
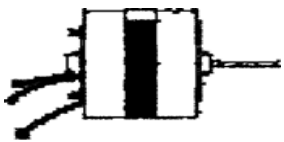
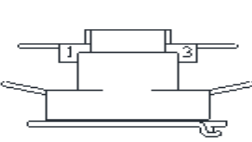
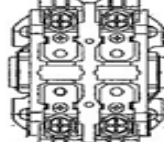
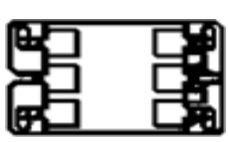
FR SERIES (OBSOLETE)									
ELEMENT					THERMOSTAT				
									
302015806 FR1527 FR1527A FR1527AIF FR1527IF FR1527LT FR1527LTIF FR1527LTPB FR1527PB	302015801 FR2020 FR2020A FR2020AIF FR2020IF FR2020LT FR2020LTIF FR2020LTPB FR2020PB	302015802 FR2024 FR2024A FR2024AIF FR2024IF FR2024LT FR2024LTIF FR2024LTPB FR2024PB	302015803 FR2027 FR2027A FR2027AIF FR2027IF FR2027LT FR2027LTIF FR2027LTPB FR2027PB	302012806 FR3027 FR3027A FR3027AIF FR3027IF FR3027LT FR3027LTIF FR3027LTPB FR3027PB	410168002 FR1527 FR1527A FR1527AIF FR1527IF FR1527PB FR2020 FR2020A FR2020AIF FR2020IF FR2020PB FR2024 FR2024A FR2024AIF FR2024IF FR2024LT FR2024LTIF FR2024LTPB FR2027 FR2027A FR2027AIF FR2027IF FR2027PB FR2027LT FR2027LTIF FR2027LTPB FR2027PB	FR2027AIF FR2027IF FR2027PB FR3027 FR3027A FR3027AIF FR3027IF FR4020 FR4020A FR4020AIF FR4020IF FR4020PB FR4024 FR4024A FR4024AIF FR4024IF FR4024LT FR4024LTIF FR4024LTPB FR4024PB	FR4024PB FR4027 FR4027A FR4027AIF FR4027IF FR4027PB FR4824 FR4824A FR4824AIF FR4824IF FR4827 FR4827A FR4827AIF FR4827IF FR4827PB FR4827LT FR4827LTIF FR4827LTPB FR4827PB		
302012807 FR4020 FR4020A FR4020AIF FR4020IF FR4020LT FR4020LTIF FR4020LTPB FR4020PB	302012808 FR4024 FR4024A FR4024AIF FR4024IF FR4024LT FR4024LTIF FR4024LTPB FR4024PB	302012809 FR4027 FR4027A FR4027AIF FR4027IF FR4027LT FR4027LTIF FR4027LTPB FR4027PB	302012810 FR4824 FR4824A FR4824AIF FR4824IF FR4824LT FR4824LTIF FR4824LTPB FR4824PB	302012811 FR4827 FR4827A FR4827AIF FR4827IF FR4827LT FR4827LTIF FR4827LTPB FR4827PB	FR4020 FR4020A FR4020AIF FR4020IF FR4020PB FR4024 FR4024A FR4024AIF FR4024IF FR4024LT FR4024LTIF FR4024LTPB FR4024PB	FR4020 FR4020A FR4020AIF FR4020IF FR4020PB FR4024 FR4024A FR4024AIF FR4024IF FR4024LT FR4024LTIF FR4024LTPB FR4024PB	FR4824AIF FR4824IF FR4824PB FR4827 FR4827A FR4827AIF FR4827IF FR4827PB		
MOTOR					LIMIT	FAN DELAY			
									
490064001 FR2020 FR2020IF FR2020LT FR2020LTIF FR2020LTPB FR2020PB FR2024 FR2024IF FR2024LT FR2024LTIF FR2024LTPB FR2024PB FR4020 FR4020IF FR4020LT		490064003 FR1527 FR1527IF FR1527LT FR1527LTIF FR1527LTPB FR1527PB FR2027 FR2027IF FR2027LT FR2027LTIF FR2027LTPB FR2027PB FR3027 FR3027IF FR3027LT		3900-2002-502 FR2020A FR2020AIF FR2024A FR2024AIF FR4020A FR4020AIF FR4024A FR4024AIF FR4824A FR4824AIF		3900-2002-503 FR1527A FR1527AIF FR2027A FR2027AIF FR3027A FR3027AIF FR4027A FR4027AIF FR4827A FR4827AIF		410169001 ALL MODELS BLADE  490030103 ALL MODELS	410074000 ALL MODELS

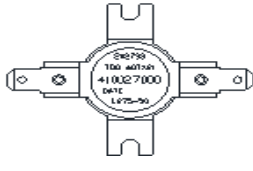
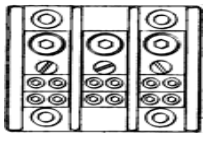
FRA SERIES WALL HEATER (OBSOLETE)									
GRILLE		ELEMENT				RELAY			
									
1402-2241-001 FRA2020B FRA4024B FRA2024B FRA40243B FRA2027B FRA4027B FRA1512 FRA4820B FRA1812 FRA48203B FRA3027B FRA4824B FRA4020B FRA48243B FRA40203B FRA4827B		302012806 FRA3027 FRA3027A FRA3027B 302012807 FRA4020 FRA4020A FRA4020B FRA4020T2 FRA4020T2A 302012808 FRA4024 FRA4024A FRA4024B FRA4024T2 FRA4024T2A	302012809 FRA4027 FRA4027A FRA4027B 302012811 FRA4827 FRA4827A FRA4827B 302012810 FRA4824 FRA4824A FRA4824B FRA4824T2 FRA4824T2A	302015801 FRA2020 FRA2020A FRA2020B 302015802 FRA2024 FRA2024A FRA2024B FRA2024T2 FRA2024T2A 302015803 FRA2027 FRA2027A FRA2027B	302015806 FRA1527 FRA1527A FRA1527B 302012827 FRA1512 302012828 FRA1812	1802-2075-800 FRA40203 FRA40203B 1802-2075-801 FRA4820 FRA48203 FRA4820B FRA48203B 1802-2075-802 FRA40243 FRA40243B 1802-2075-803 FRA48243 FRA48243B	5018-2017-004 FRA40203 FRA4820 FRA48203 FRA40203B FRA48203B	5018-2017-000 FRA40243 FRA48243 FRA40243B FRA48243B	
MANUAL LIMIT		HI LIMIT	MOTOR			FAN DELAY			
									
4520-2027-000 FRA40203 FRA2027B FRA40243 FRA1512 FRA4820 FRA1812 FRA48203 FRA3027B FRA48243 FRA4020B FRA1527A FRA40203B FRA2020A FRA4024B FRA2024A FRA40243B FRA2027A FRA4027B FRA3027A FRA4820B FRA4020A FRA48203B FRA4024A FRA4824B FRA4027A FRA48243B FRA4824A FRA4827B FRA4827A FRA2024T2A FRA1527B FRA4020T2A FRA2020B FRA4024T2A FRA2024B FRA4824T2A		410169001 FRA1527 FRA2020 FRA2024 FRA3027 FRA4027 FRA3027 FRA4020 FRA4024 FRA4027 FRA4824 FRA4827 FRA2024T2 FRA4020T2 FRA4024T2 FRA4824T2	3900-2002-501 FRA1527 FRA2027 FRA3027 FRA4027 FRA4827 3900-2010-000 FRA2020A FRA2024A FRA4020A FRA4024A FRA4824A FRA2020B FRA2024B FRA4020B FRA4024B FRA4824B FRA2024T2A FRA4020T2A FRA4024T2A FRA4824T2A	3900-2002-500 FRA2020 FRA2024 FRA4020 FRA4024 FRA4824 FRA2024T2 FRA4020T2 FRA4024T2 FRA4824T2 3900-2010-001 FRA1527 FRA2027A FRA3027A FRA4027A FRA4827A FRA1527B FRA2027B FRA3027B FRA4027B FRA4827B	3900-2002-518 FRA40203 FRA40243 FRA48203 FRA48243 FRA40203B FRA40243B FRA48203B FRA48243B 3900-2010-003 FRA1512 FRA1812	4520-2024-000 FRA40203 FRA40243 FRA4820 FRA48203 FRA48243 FRA48203B	FRA1527 FRA1527A FRA1527B FRA2020 FRA2020A FRA2024 FRA2024A FRA2024B FRA2024T2 FRA2027 FRA2027A FRA2027B FRA3027	410074000 FRA3027A FRA3027B FRA4020 FRA4020A FRA4020B FRA4020T2 FRA4020T2A FRA4024 FRA4024A FRA4024B FRA4024T2 FRA4027A FRA4027B	FRA4824 FRA4824A FRA4824B FRA4824T2 FRA4824T2A FRA4827 FRA4827A FRA4827B FRA1512
THERMOSTAT		DISCONNECT SWITCH			FAN BLADE	PLASTIC COVER(2REQ)	KNOB		
									
410168002 FRA1527 FRA2020 FRA2024 FRA2027 FRA3027 FRA4020 FRA40203 FRA4024 FRA40243 FRA4027 FRA4820 FRA48203 FRA4824 FRA48243 FRA4827 FRA1527A FRA2020A FRA2024A FRA2027A FRA3027A FRA4020A FRA4024A FRA4027A FRA4824A FRA4827A	5813-2059-000 FRA1527B FRA2020B FRA2024B FRA2027B FRA1512 FRA1812 FRA3027B FRA4020B FRA40203B FRA4024B FRA40243B FRA4027B FRA4820B FRA48203B FRA4824B FRA48243B FRA4827B	5813-2027-000 FRA2024T2 FRA4020T2 FRA4024T2 FRA4824T2 FRA2024T2A FRA4020T2A FRA4024T2A FRA4824T2A	5216-2019-000 FRA40203 FRA40243 FRA4820 FRA48203 FRA48243 FRA40203B FRA40243B FRA4820B FRA48203B FRA48243B	410170001 FRA1527 FRA2020 FRA2024 FRA2027 FRA3027 FRA4020 FRA4024 FRA4027 FRA4824 FRA4827 FRA1527A FRA2020A FRA2024A FRA2027A FRA3027A FRA4020A FRA4024A FRA4027A FRA4824A FRA4827A	FRA1527B FRA2020B FRA2024B FRA2027B FRA1512 FRA1812 FRA3027B FRA4020B FRA4024B FRA4027B FRA4824B FRA4827B FRA2024T2 FRA4020T2 FRA4024T2 FRA4824T2 FRA2024T2A FRA4020T2A FRA4024T2A FRA4824T2A	490030103 ALL MODELS	1402-2120-000 ALL MODELS	3301-2014-001 ALL MODELS	
									

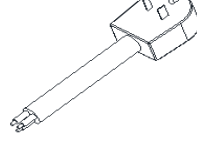
FRC SERIES (OBSOLETE)										
GRILLE				FAN DELAY				RELAY		
										
2501-2003-007				4520-2024-000				5018-2017-004		5018-2017-000
FRC40203	FRC2027AIF	FRC4827AIF	FRC2020C	FRC40203	FRC1527	FRC1527B	FRC1527A	FRC40203	FRC40243	
FRC40243	FRC3027A	FRC1527B	FRC2024C	FRC40243	FRC1527IF	FRC2027B	FRC1527AIF	FRC4820	FRC48243	
FRC4820	FRC3027AIF	FRC2020B	FRC2027C	FRC4820	FRC2027	FRC3027B	FRC3027A	FRC48203	FRC40243C	
FRC48203	FRC4020A	FRC2024B	FRC3027C	FRC48203	FRC2027IF	FRC4027B	FRC3027AIF	FRC40203C	FRC48243C	
FRC48243	FRC4020AIF	FRC2027B	FRC4020C	FRC48243	FRC3027	FRC4827B	FRC4027A	FRC4820C		
FRC1527A	FRC4024A	FRC3027B	FRC40203C	FRC40203C	FRC3027IF	FRC1527C	FRC4027AIF	FRC48203C		
FRC1527AIF	FRC4024AIF	FRC4020B	FRC4024C	FRC40243C	FRC4027	FRC2027C	FRC4827A			
FRC2020A	FRC4027A	FRC4024B	FRC40243C	FRC4820C	FRC4027IF	FRC3027C	FRC4827AIF			
FRC2020AIF	FRC4027AIF	FRC4027B	FRC4027C	FRC48203C	FRC4827	FRC4027C	FRC2020A			
FRC2024A	FRC4824A	FRC4824B	FRC4820C	FRC48243C	FRC4827IF	FRC4827C	FRC2020AIF			
FRC2024AIF	FRC4824AIF	FRC4827B	FRC48203C		FRC2020	FRC2020B	FRC2024A			
FRC2027A	FRC4827A	FRC1527C	FRC4824C		FRC2020IF	FRC2024B	FRC2024AIF			
			FRC48243C		FRC4020	FRC4020B	FRC4020A			
			FRC4827C		FRC4020IF	FRC4024B	FRC4020AIF			
					FRC2024	FRC4824B	FRC4024A			
					FRC2024IF	FRC2020C	FRC4024AIF			
					FRC4024	FRC2024C	FRC4824A			
					FRC4024IF	FRC4020C	FRC4824AIF			
					FRC4824	FRC4024C				
					FRC4824IF	FRC4824C				
ELEMENTS				MOTOR				FAN BLADE	THERMOSTAT	
										
302015806	302015801	302015802	302015803	490064003	3900-2010-001	3900-2002-501	3900-2002-518	490030103	410168002	
FRC1527	FRC2020	FRC2024	FRC2027	FRC1527	FRC1527B	FRC1527A	FRC40203	ALL MODELS	ALL MODELS	
FRC1527IF	FRC2020IF	FRC2024IF	FRC2027IF	FRC1527IF	FRC2027B	FRC1527AIF	FRC40243			
FRC1527A	FRC2020A	FRC2024A	FRC2027A	FRC2027	FRC3027B	FRC3027A	FRC4820			
FRC1527AIF	FRC2020AIF	FRC2024AIF	FRC2027AIF	FRC2027IF	FRC4027B	FRC3027AIF	FRC48203			
FRC1527B	FRC2020B	FRC2024B	FRC2027B	FRC3027	FRC4827B	FRC4027A	FRC48243			
FRC1527C	FRC2020C	FRC2024C	FRC2027C	FRC3027IF	FRC1527C	FRC4027AIF	FRC40203C			
				FRC4027	FRC2027C	FRC4827A	FRC40243C			
				FRC4027IF	FRC3027C	FRC4827AIF	FRC4820C			
				FRC4827	FRC4027C	3900-2002-500	FRC48203C			
				FRC4827IF	FRC4827C	FRC2020A	FRC48243C			
				490064001	3900-2010-000	FRC2020AIF	490064002			
				FRC2020	FRC2020B	FRC2024A	FRC2024			
				FRC2020IF	FRC2024B	FRC2024AIF	FRC2024IF			
				FRC4020	FRC4020B	FRC4020A	FRC4024			
				FRC4020IF	FRC4024B	FRC4020AIF	FRC4024IF			
					FRC4824B	FRC4024A	FRC4824			
					FRC2020C	FRC4024AIF	FRC4824IF			
					FRC2024C	FRC4824A				
					FRC4020C	FRC4824AIF				
					FRC4024C					
					FRC4824C					
DISCONNECT SWITCH				MANUAL LIMIT				HI LIMIT		
										
5216-2019-000	410170001			4520-2027-000				410169001		
FRC40203	FRC1527	FRC2020B	FRC2024A	FRC2027	FRC1527B	FRC2020C	FRC1527	FRC4027	FRC2027	
FRC40243	FRC1527IF	FRC2020C	FRC2024AIF	FRC2027IF	FRC2027B	FRC2024C	FRC1527IF	FRC4027IF	FRC2027IF	
FRC4820	FRC1527A	FRC4020	FRC2024B	FRC2027A	FRC3027B	FRC4020C	FRC1527A	FRC4027A	FRC2027A	
FRC48203	FRC1527AIF	FRC4020IF	FRC2024C	FRC2027AIF	FRC4027B	FRC4024C	FRC1527AIF	FRC4027AIF	FRC2027AIF	
FRC48243	FRC1527B	FRC4020A	FRC4824	FRC2027B	FRC4827B	FRC4824C	FRC3027	FRC2024	FRC4024	
FRC40203C	FRC1527C	FRC4020AIF	FRC4824IF	FRC2027C	FRC2020B	FRC40203	FRC3027IF	FRC2024IF	FRC4024IF	
FRC40243C	FRC3027	FRC4020B	FRC4824A	FRC4024	FRC2024B	FRC40243	FRC3027A	FRC2024A	FRC4024A	
FRC4820C	FRC3027IF	FRC4020C	FRC4824IFA	FRC4024IF	FRC4020B	FRC4820	FRC3027AIF	FRC2024AIF	FRC4024AIF	
FRC48203C	FRC3027A	FRC4027	FRC4824B	FRC4024A	FRC4024B	FRC48203	FRC2020	FRC4824		
FRC48243C	FRC3027AIF	FRC4027IF	FRC4824C	FRC4024AIF	FRC4824B	FRC48243	FRC2020IF	FRC4824IF		
	FRC3027B	FRC4027A	FRC4827	FRC4024B	FRC1527C	FRC40203C	FRC2020A	FRC4824A		
	FRC3027C	FRC4027AIF	FRC4827IF	FRC4024C	FRC2027C	FRC40243C	FRC2020AIF	FRC4824IFA		
	FRC2020	FRC4027B	FRC4827A		FRC3027C	FRC4820C	FRC4020	FRC4827		
	FRC2020IF	FRC4027C	FRC4827IFA		FRC4027C	FRC48203C	FRC4020IF	FRC4827IF		
	FRC2020A	FRC2024	FRC4827B		FRC4827C	FRC48243C	FRC4020A	FRC4827A		
	FRC2020AIF	FRC2024IF	FRC4827C				FRC4020AIF	FRC4827IFA		

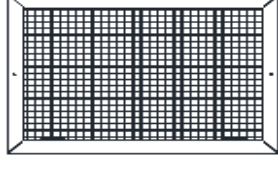
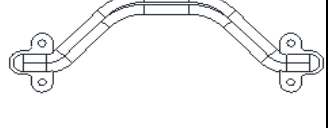
WPC SERIES (OBSOLETE)			
ELEMENT	TIP OVER SW.	LIMIT	THERMOSTAT
			
1802-10822-000 WPC1500A 1802-11017-000 (500W) 1802-11017-001 (1000W) WPC1500B WPC1500C	5216-11004-000 WPC1500A	410122002 WPC1500A 4520-11004-003 WPC1500B WPC1500C	5813-2092-001 WPC1500A WPC1500B WPC1500C
4 POSITION SW.	PORT SWITCH	LIGHT RED	PILOT LIGHT AMBER
			
5216-2071-000 WPC1500A WPC1500B WPC1500C	5216-2073-000 WPC1500A WPC1500B WPC1500C	3510-2021-002 WPC1500A 3510-2021-004 WPC1500B WPC1500C	3510-11518-000 WPC1500A WPC1500B WPC1500C
WHEEL KIT (2 REQ)	HOLE PLUG (2 REQ)	CORD	KNOB (2 REQ)
			
1205-10305-000 WPC1500A WPC1500B WPC1500C	4506-2022-000 WPC1500A WPC1500B WPC1500C	1420-2029-009 WPC1500A WPC1500B WPC1500C	3301-2058-000 WPC1500A WPC1500B WPC1500C



TBX SERIES (OBS)					
ELEMENT	MOTOR	TIME DELAY RELAY	CONTACTOR 30AMP	CONTACTOR 50AMP	THERMOSTAT
					
302006814 TBX754	490059004 ALL MODELS	410171003 ALL MODELS	5018-0003-002 ALL MODELS	5018-0006-002 ALL MODELS	5813-2059-000 ALL MODELS
302006813 TBX104					
BLADE	HI LIMIT	TERMINAL BLOCK	TOOL BOX COVER	CORD	KNOB
					
490011001 ALL MODELS	410169001 ALL MODELS	480100001 ALL MODELS	1016-0193-800 ALL MODELS	1016-10593-000 ALL MODELS	3301-2053-000 ALL MODELS
AXLE	GRILLE	COLLAPSABLE HANDLE	HANDLE	WHEEL (2 REQ)	AXLE CAP (2 REQ)
					
1017-0004-000 ALL MODELS	2501-10513-800 ALL MODELS	2710-10586-000 ALL MODELS	2710-2012-800 ALL MODELS	6406-0002-000 ALL MODELS	1408-10584-000 ALL MODELS





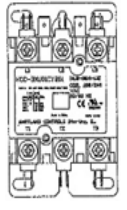
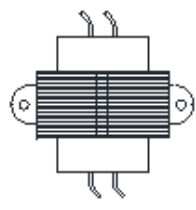
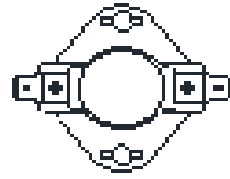
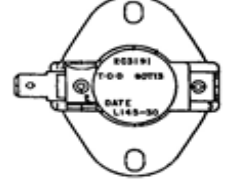
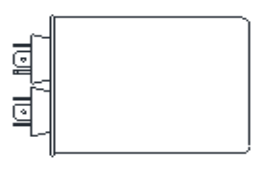

CUH OBSOLETE

DISCRIPTION	PART NUMBERS			
	CUH3	CUH4	CUH6	CUH7
FAN MOTOR: SINGLE SHAFT	3900-2032-000*	-	3900-2032-000	-
DOUBLE SHAFT	-	3900-2033-000*	3900-2033-000	3900-2033-000**
POWER TRANSFORMER: 277V	490015009	490015009	490015007	490015007
480V	490015010	490015010	490015008	490015008
* ONE REQUIRED ** TWO REQUIRED				
CIRCUIT BREAKERS				
REPLACEMENT CIRCUIT BREAKERS, FOR HEATERS SO EQUIPPED, ARE STANDARD, OFF-THE-SHELF ITEMS INVENTORIED BY MOST ELECTRICAL DISTRIBUTORS.				



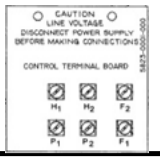
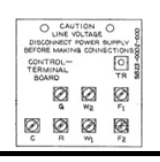
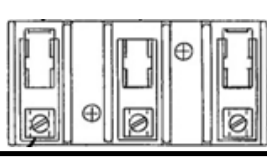
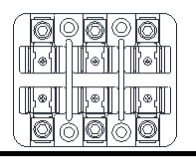



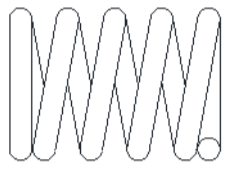
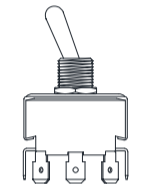
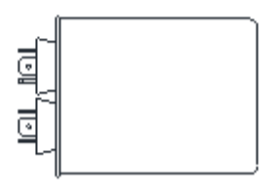



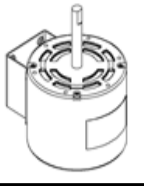
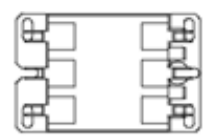
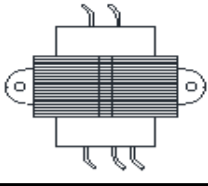

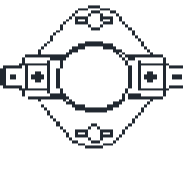
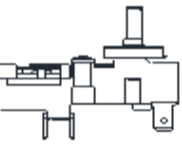

VUH & VUH-A

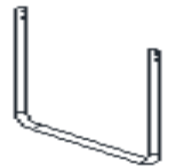
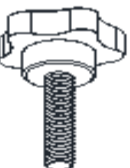
BLADE	RELAY		TRANSFORMER	
				
490020000	5018-0005-006		490015018	490015008
H2520	H1020A	H1048A	H1034A	H5048
H2524	H1024A	H1555A	H1534A	H5055
H2548	H1027A	H1560A	490015019	490015012
H2555	H1034A	H2020	H2034	H2060
H2560	H1048A	H2024	490015021	H2560
H3020	H1055A	H2027	H1060A	H3060
H3024	H1060A	H2034	H1560A	H4060
H3048	H1520A	H2048	490015005	490015015
H3055	H1524A	H2055	H2027	H5060
H3060	H1527A	H2060		
H4020	H1534A			
H4024				
H4048				
H4055				
H4060				
LIMIT	FAN DELAY	CAPACITOR		
				
410029000	410126000	1432-0002-003		
ALL MODELS	ALL MODELS	ALL MODELS		

HUHAA CONTINUED

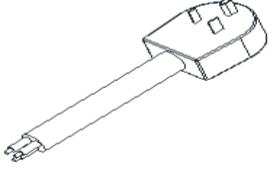

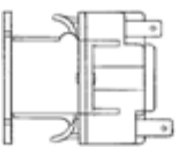

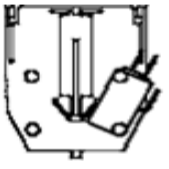
CONTROL BOARD						POWER BLOCK				FUSE BLOCK	FUSE				
															
5823-0001-000 HUHAA320 HUHAA324 HUHAA327 HUHAA520 HUHAA524 HUHAA527		5823-0002-000 HUHAA348 HUHAA548 HUHAA724 HUHAA727 HUHAA748 HUHAA1020 HUHAA1024 HUHAA1027 HUHAA1048 HUHAA1520 HUHAA1524 HUHAA1548				5823-0004-000 HUHAA320 HUHAA324 HUHAA327 HUHAA348 HUHAA520 HUHAA524 HUHAA527 HUHAA548 HUHAA720 HUHAA724 HUHAA727 HUHAA748 HUHAA1020 HUHAA1024 HUHAA1027 HUHAA1048 HUHAA1548 HUHAA2048				5823-0004-001 HUHAA1524 HUHAA2548 HUHAA2548A HUHAA3048 HUHAA3048A 5823-0004-002 HUHAA2020 HUHAA2024 HUHAA2524 HUHAA4048 HUHAA5048 5823-0004-003 HUHAA1520 HUHAA3024 5823-0005-000 HUHAA3020 HUHAA4024 HUHAA5020 HUHAA5024		2025-0002-000 HUHAA1520 HUHAA2020 480030004 HUHAA2524 HUHAA3020 HUHAA3024 HUHAA4024 HUHAA5020 HUHAA5024 2025-0001-000 HUHAA5048 2025-7004-000 HUHAA5048		2019-0007-010 HUHAA1520 2019-0007-008 HUHAA2020 2019-7008-077 HUHAA2524 2019-7008-080 HUHAA3020 HUHAA5020 2019-7008-079 HUHAA3024 HUHAA5024 2019-7008-078 HUHAA4024 2019-7002-008 HUHAA5048 2019-7002-012 HUHAA5048	
LOUVERS		LOUVER SPRING		HI/LOW SW.		CAPACITOR									
QUANTITY 3&5KW (5) 7 THRU 20KW (6) 25 THRU 50KW (9) 															
3503-2004-106 HUHAA320 HUHAA324 HUHAA327 HUHAA348 HUHAA520 HUHAA524 HUHAA527 HUHAA548		3503-2004-101 HUHAA720 HUHAA724 HUHAA727 HUHAA748 HUHAA1020 HUHAA1024 HUHAA1027 HUHAA1048 HUHAA1520 HUHAA1524 HUHAA1548 HUHAA2020 HUHAA2048		3503-2004-108 HUHAA2524 HUHAA2548 HUHAA2548A HUHAA3020 HUHAA3024 HUHAA3048 HUHAA3048A HUHAA4024 HUHAA4048 HUHAA5020 HUHAA5024 HUHAA5048		5208-7005-001 ALL MODELS		5216-2053-000 HUHAA2524 HUHAA2548 HUHAA2548A HUHAA3020 HUHAA3024 HUHAA3048 HUHAA3048A HUHAA4024 HUHAA4048 HUHAA5020 HUHAA5024 HUHAA5048				1432-0002-003 HUHAA2020 HUHAA2024 HUHAA2048 HUHAA2524 HUHAA2548 1432-0002-001 HUHAA3020 HUHAA2548A HUHAA3048A 1432-0002-004 HUHAA4024 HUHAA4048 HUHAA5020 HUHAA5024 HUHAA5048			

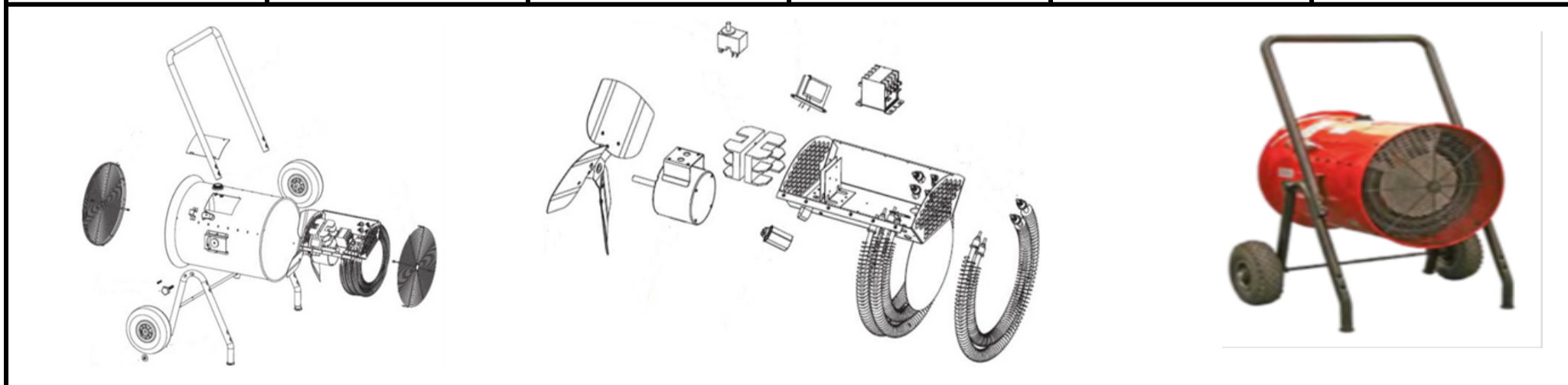
BDH SERIES

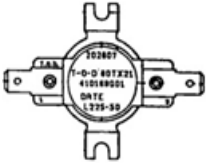
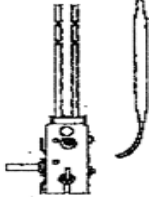
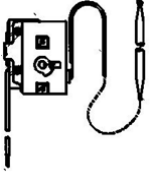
ELEMENT SMALL	ELEMENT LARGE	MOTOR	CONTACTOR		TRANSFORMER
					
1802-11001-000 DH1583A DH1583B DH1583C	1802-11001-001 DH1583A DH1583B DH1583C	3900-11002-000 DH1021A DH1021CKA DH1021CKB DH1021CKC DH1521A DH1521B DH1521C DH1523A DH1523B DH1523C DH1583A DH1583B DH1543C	5018-0006-000 DH1543A DH1543B DH1543C DH3043A DH3043B DH3043C	5018-0006-004 DH1021A DH1021CKA DH1021CKB DH1521A DH1521B DH1521C DH1523A DH1523B DH1523C DH1583A DH1583B DH1583C	5814-0003-002 DH1543A DH1543B DH1543C DH3043A DH3043B DH3043C
1802-11001-002 DH1021A DH1021CKA DH1021CKB DH1021CKC DH1521A DH1521B DH1521C DH1523A DH1523B DH1523C DH1543A DH1543B DH1543C DH3043A DH3043B DH3043C	1802-11001-003 DH1021A DH1021CKA DH1021CKB DH1021CKC DH1521A DH1521B DH1521C DH1523A DH1523B DH1523C DH1543A DH1543B DH1543C DH3043A DH3043B DH3043C	3900-11002-001 DH1543A DH1543B DH1543C DH3043A DH3043B DH3043C	5018-0006-002 DH1021CKC		
FAN BLADE	HI LIMIT	THERMOSTAT	CAPACITOR	GUARD REAR	GUARD FRONT
					
1210-0098-001 ALL MODELS	410029000 ALL MODELS	5813-2059-000 ALL MODELS	1432-0002-003 ALL MODELS	2504-11004-000 ALL MODELS	2504-11005-000 ALL MODELS
HANDLE	CART KNOB	THERMOSTAT KNOB	WHEEL	SHAFT CAP	AXEL SHAFT
					
2710-11001-000 ALL MODELS	3301-11003-000 ALL MODELS	3301-11018-002 ALL MODELS	6406-11001-000 ALL MODELS	1408-11002-000 ALL MODELS	5217-11001-000 ALL MODELS
CORD	FUSE	FUSE BLOCK	FAN RELAY	FAN DELAY	AUXILIARY SWITCH
					
1016-10593-000 DH1021CKA DH1021CKB SCS10063 DH1021CKC	2019-7008-077 DH1521A DH1521B DH1521C	480030007 DH1521A DH1521B DH1521C	5018-0007-000 DH1543A DH1543B DH1543C DH3043A DH3043B DH3043C	1414-2039-000 DH3043C	5216-10564-000 DH1521C DH1543A DH1543B DH1543C DH3043A DH3043B DH3043C

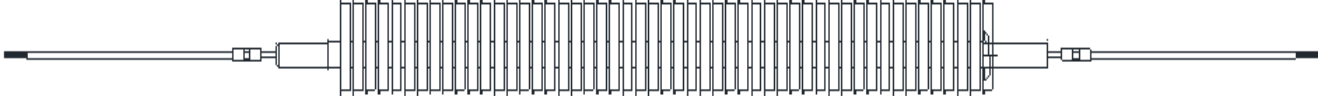





CC & DCC		
SPOT LIMIT	THERMOSTAT 1-POLE	THERMOSTAT 2-POLE
		
410027000 ALL MODELS	410112000 ALL MODELS	410113000 ALL MODELS

DB SERIES				
				
DISCRIPTION	PART NUMBERS			
	120V	208V	240V	277V
*ELEMENT (100 WATTS/FT)				
38"	1802-2016-014	1802-2016-006	1802-2016-007	1802-2016-015
50"	1802-2016-016	1802-2016-017	1802-2016-018	1802-2016-019
62"	1802-2016-026	1802-2016-027	1802-2016-028	1802-2016-029
*ELEMENT (188 WATTS/FT)				
38"	1802-2016-012	1802-2016-010	1802-2016-011	1802-2016-013
50"	1802-2016-020	1802-2016-024	1802-2016-025	1802-2016-021
62"	1802-2016-030	1802-2016-034	1802-2016-035	1802-2016-031
				
LINEAR LIMIT	TERMINAL BOX COVER	ELEMENT HANGER CLIP		
38"	410122003	310527001	402020000	
50"	410122004			
62"	410122005			

FRR & PMRR SERIES (OBSOLETE)



ELEMENT

			
1802-0070-509 RR22012A	1802-2113-501 RR41512A	1802-2119-500 RR10512A RR11012A	1802-2151-001 RR26164
1802-0070-550 RR35724A	1802-2113-516 RR53024A		1802-2151-000 RR26168

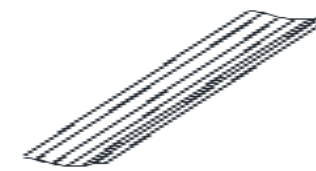
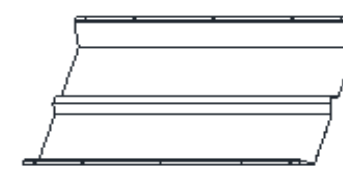
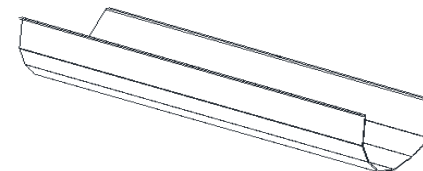
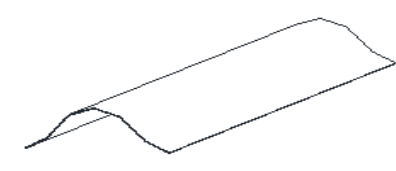
REFLECTOR

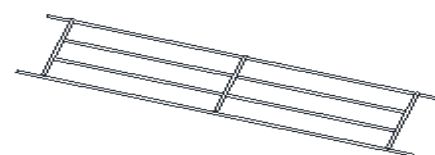

			
5007-2013-000 RR41512A 5007-2013-001 RR53024A	5007-2020-000 RR22012A 5007-2020-001 RR35724A	5007-2021-000 RR10512A RR11012A	5007-2027-000 RR26164 RR26168

WIRE GUARD

			
2504-2014-000 RR35724A	2504-2015-000 RR22012A	2504-2016-000 RR41512A 2504-2016-001 RR53024A 2504-2016-002 RR26164 RR26168	2504-2017-000 RR10512A RR11012A

CERAMIC BLOCK

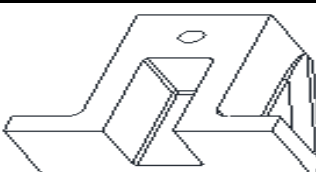
SWITCH

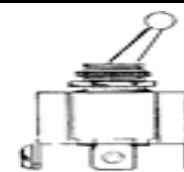
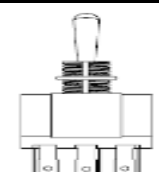

			
1224-0049-000 RR22012A RR26164 RR26168 RR35724A	1224-2006-000 RR10512A RR11012A	410024000 RR11012A	5216-11009-000 RR22012A RR35724A

ELEMENT BUSHING

CORD

CHAIN 4'

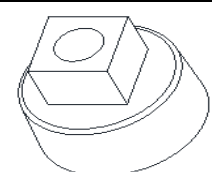
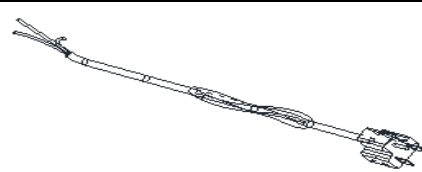
"S" HOOKS

			
1213-0070-000 RR22012A RR26164 RR26168 RR35724A	1420-2016-000 RR10512A RR41512A 1420-2016-008 RR11012A 1420-2016-002 RR22012A 1420-2031-000 RR35724A 1420-2016-001 RR53024A	1404-2000-001 RR10512A RR11012A RR22012A RR35724A RR41512A RR53024A	2706-2000-000 RR10512A RR11012A RR22012A RR35724A RR41512A RR53024A



RH SERIES

KEY NUMBER	DESCRIPTION	PART NUMBER		
		RH__26	RH__35	RH__48
1	REFLECTOR: 60/90 SYM	-	-	-
	30 DEGREES SYM	-	-	-
	60/90 ASYM	-	-	-
	30 DEGREES ASYM	-	-	-
2	INSULATOR	-	-	-
3	TERMINAL BLOCK (4 REQ)	1224-0049-000	1224-0049-000	1224-0049-000
4	ELEMENT TERM. BUSH. (4 REQ)	1213-0070-000	1213-0070-000	1213-0070-000
ELEMENTS				
-	RH16-91S-208	2QL16208		
	RH16-91S-240	2QL16240		
	RH16-91S-277	2QL16277		

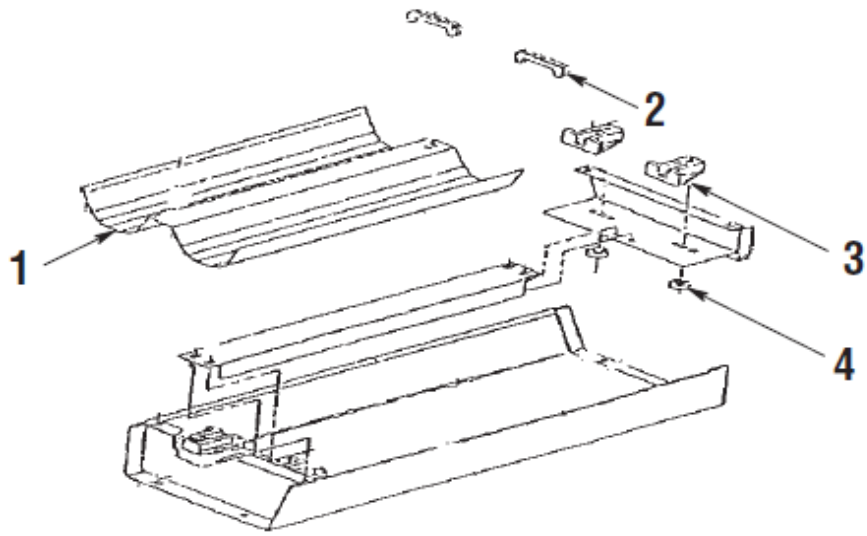

INDUSTRIAL CEILING FANS (FANS ARE PHASED OUT SOME PARTS MAY NOT BE AVAILABLE)

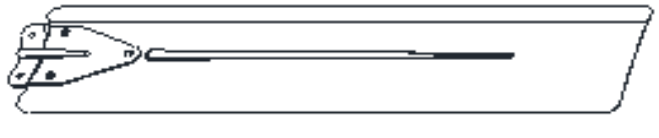
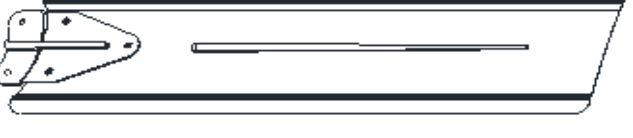

BLADE (SET)

					
9B3620-1 36201	9B4820-3 48203	9B5600-1 56001	9B6000-1 60001	9B5630-1R 56301RDP	
9B4820-1 48201 48207	9B5600-1LC 56001LC 56101	56002 56003 56007	9B6001-1 60011		
9B4820-1B 48201B	56111	9B5601-1 56011	9B6011-1 60101 60111		
		9B5600-1B 56001B	9B5620-1 56201		

DOWNROD 24"

DOWNROD 8"

MOTOR

					
9D24BW 36201 48201 56001LC 56001 56002 56003 56007 56301RDP 48203 48207 60001 56201	9D24BLK 48201B 56001B 9D24BB 56011 60011 9D12TW 56101 56111 60101 60111	9D08 36201 48201 56001LC 56003 48203 9D08BLK 48201B	9M3620-1-A 36201 9M4820-1-A 48201 9M4820-1B-A 48201B 9M4820-3-A 48203 9M5600-7-A 48207 6011-1U 60101 60111	9M5600-1LC-A 56001LC 9M5600-1-A 56001 9M5600-1B-A 56001B 9M5600-4-A 56002 9M5600-3-A 56003 9M5600-7-A 56007	9M5601-1-A 56011 5611-1U 56101 56111 9M5630-1R-A 56301RDP 9M6000-1-A 60001 9M6001-1-A 60011 9M5620-1-A 56201

RUBBER ROLLER





J HOOK KIT

BLADE SCREWS (6 REQ)

BLADE PADS (3 REQ)

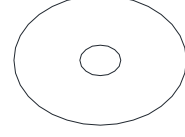
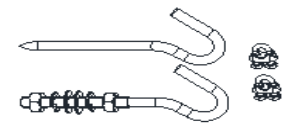
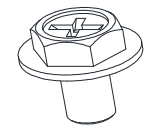
REVERSIBLE TOGGLE

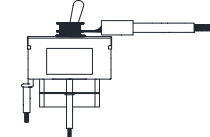
REVERSING SW. PLATE

					
9F2900-04A ALL MODELS	9F2900-01 ALL MODELS	9F2900-20A ALL MODELS	9F2900-19A ALL MODELS	9F2GX54-73 56301RDP	9FP005 56301RDP

CANOPY UPPER

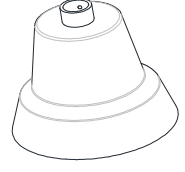
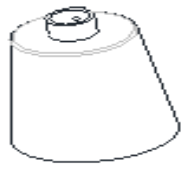

CANOPY LOWER

					
9F2900-07A 36201 48201 56001LC 56001 56002 56003 56007 56301RDP 48203 48207 60001 56201	9F2900-07AB 48201B 56001B 9FP029 56011 60011 3100039A 56101 56111 60101 60111	9F2900-08A 36201 48201 56001LC 56001 56002 56003 56007		60001 60101 60111 56301RDP 48203 48207 56101 56111	9F2900-08AB 48201B 56001B 9FP030 56011 60011

3-SPEED PULL CHAIN SW.

PULL CHAIN STRING

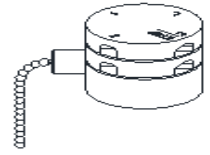
OUTDOOR KIT

		PICTURE NOT AVAILABLE
9F2900-26 48203 56003	3378 48203 56003	

